

- Таблица обозначений
- 1 - Межкомнатный трубопровод
 - 2 - Трубопровод наружного назначения
 - 3 - Канализационный трубопровод
 - 4 - Трубопровод холодного водоснабжения
 - 5 - Трубопровод горячего водоснабжения

Код	Наименование	Единица измерения	Количество	Примечание
1	Трубопровод	м	100	
2	Трубопровод	м	100	
3	Трубопровод	м	100	
4	Трубопровод	м	100	
5	Трубопровод	м	100	
6	Трубопровод	м	100	
7	Трубопровод	м	100	
8	Трубопровод	м	100	
9	Трубопровод	м	100	
10	Трубопровод	м	100	
11	Трубопровод	м	100	
12	Трубопровод	м	100	
13	Трубопровод	м	100	
14	Трубопровод	м	100	
15	Трубопровод	м	100	
16	Трубопровод	м	100	
17	Трубопровод	м	100	
18	Трубопровод	м	100	
19	Трубопровод	м	100	
20	Трубопровод	м	100	
21	Трубопровод	м	100	
22	Трубопровод	м	100	
23	Трубопровод	м	100	
24	Трубопровод	м	100	
25	Трубопровод	м	100	
26	Трубопровод	м	100	
27	Трубопровод	м	100	
28	Трубопровод	м	100	
29	Трубопровод	м	100	
30	Трубопровод	м	100	
31	Трубопровод	м	100	
32	Трубопровод	м	100	
33	Трубопровод	м	100	
34	Трубопровод	м	100	
35	Трубопровод	м	100	
36	Трубопровод	м	100	
37	Трубопровод	м	100	
38	Трубопровод	м	100	
39	Трубопровод	м	100	
40	Трубопровод	м	100	
41	Трубопровод	м	100	
42	Трубопровод	м	100	
43	Трубопровод	м	100	
44	Трубопровод	м	100	
45	Трубопровод	м	100	
46	Трубопровод	м	100	
47	Трубопровод	м	100	
48	Трубопровод	м	100	
49	Трубопровод	м	100	
50	Трубопровод	м	100	
51	Трубопровод	м	100	
52	Трубопровод	м	100	
53	Трубопровод	м	100	
54	Трубопровод	м	100	
55	Трубопровод	м	100	
56	Трубопровод	м	100	
57	Трубопровод	м	100	
58	Трубопровод	м	100	
59	Трубопровод	м	100	
60	Трубопровод	м	100	
61	Трубопровод	м	100	
62	Трубопровод	м	100	
63	Трубопровод	м	100	
64	Трубопровод	м	100	
65	Трубопровод	м	100	
66	Трубопровод	м	100	
67	Трубопровод	м	100	
68	Трубопровод	м	100	
69	Трубопровод	м	100	
70	Трубопровод	м	100	
71	Трубопровод	м	100	
72	Трубопровод	м	100	
73	Трубопровод	м	100	
74	Трубопровод	м	100	
75	Трубопровод	м	100	
76	Трубопровод	м	100	
77	Трубопровод	м	100	
78	Трубопровод	м	100	
79	Трубопровод	м	100	
80	Трубопровод	м	100	
81	Трубопровод	м	100	
82	Трубопровод	м	100	
83	Трубопровод	м	100	
84	Трубопровод	м	100	
85	Трубопровод	м	100	
86	Трубопровод	м	100	
87	Трубопровод	м	100	
88	Трубопровод	м	100	
89	Трубопровод	м	100	
90	Трубопровод	м	100	
91	Трубопровод	м	100	
92	Трубопровод	м	100	
93	Трубопровод	м	100	
94	Трубопровод	м	100	
95	Трубопровод	м	100	
96	Трубопровод	м	100	
97	Трубопровод	м	100	
98	Трубопровод	м	100	
99	Трубопровод	м	100	
100	Трубопровод	м	100	

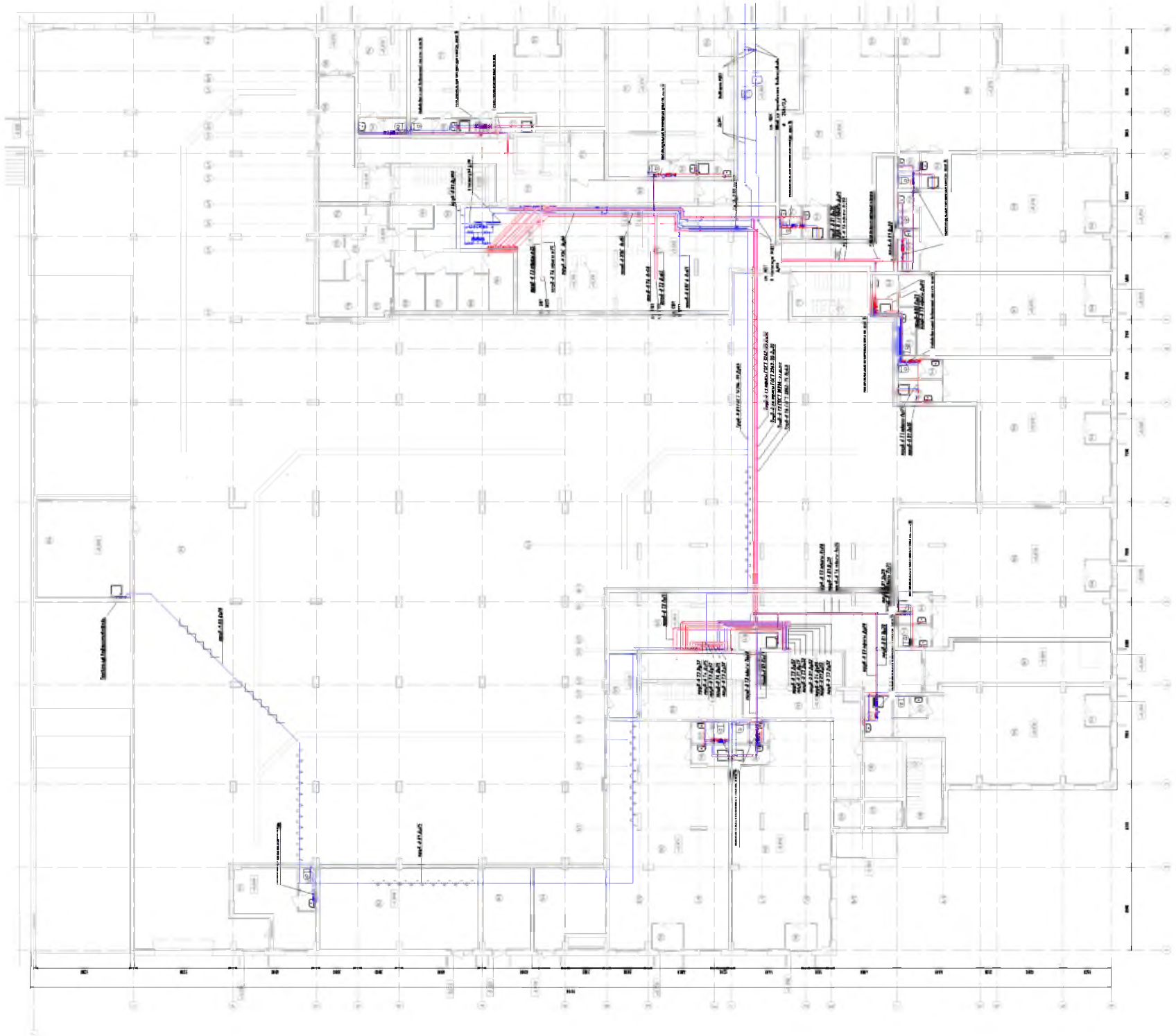

- Legenda**
- 1 - Kanalizacija
 - 2 - Voda
 - 3 - Plin
 - 4 - Električni sistem
 - 5 - Telekomunikacioni sistem
 - 6 - Voda za grijanje
 - 7 - Hladnja
 - 8 - Hladnja za grijanje
 - 9 - Hladnja za hlađenje
 - 10 - Hladnja za hlađenje
 - 11 - Hladnja za hlađenje
 - 12 - Hladnja za hlađenje
 - 13 - Hladnja za hlađenje
 - 14 - Hladnja za hlađenje
 - 15 - Hladnja za hlađenje
 - 16 - Hladnja za hlađenje
 - 17 - Hladnja za hlađenje
 - 18 - Hladnja za hlađenje
 - 19 - Hladnja za hlađenje
 - 20 - Hladnja za hlađenje
 - 21 - Hladnja za hlađenje
 - 22 - Hladnja za hlađenje
 - 23 - Hladnja za hlađenje
 - 24 - Hladnja za hlađenje
 - 25 - Hladnja za hlađenje
 - 26 - Hladnja za hlađenje
 - 27 - Hladnja za hlađenje
 - 28 - Hladnja za hlađenje
 - 29 - Hladnja za hlađenje
 - 30 - Hladnja za hlađenje
 - 31 - Hladnja za hlađenje
 - 32 - Hladnja za hlađenje
 - 33 - Hladnja za hlađenje
 - 34 - Hladnja za hlađenje
 - 35 - Hladnja za hlađenje
 - 36 - Hladnja za hlađenje
 - 37 - Hladnja za hlađenje
 - 38 - Hladnja za hlađenje
 - 39 - Hladnja za hlađenje
 - 40 - Hladnja za hlađenje
 - 41 - Hladnja za hlađenje
 - 42 - Hladnja za hlađenje
 - 43 - Hladnja za hlađenje
 - 44 - Hladnja za hlađenje
 - 45 - Hladnja za hlađenje
 - 46 - Hladnja za hlađenje
 - 47 - Hladnja za hlađenje
 - 48 - Hladnja za hlađenje
 - 49 - Hladnja za hlađenje
 - 50 - Hladnja za hlađenje

Redni broj	Opis	Skupina	Ukupna dužina	Ukupna površina	Ukupna zapremina	Ukupna težina	Ukupna vrijednost
1
2
3
4
5
6
7
8
9
10
11
12
13
14
15
16
17
18
19
20
21
22
23
24
25
26
27
28
29
30
31
32
33
34
35
36
37
38
39
40
41
42
43
44
45
46
47
48
49
50

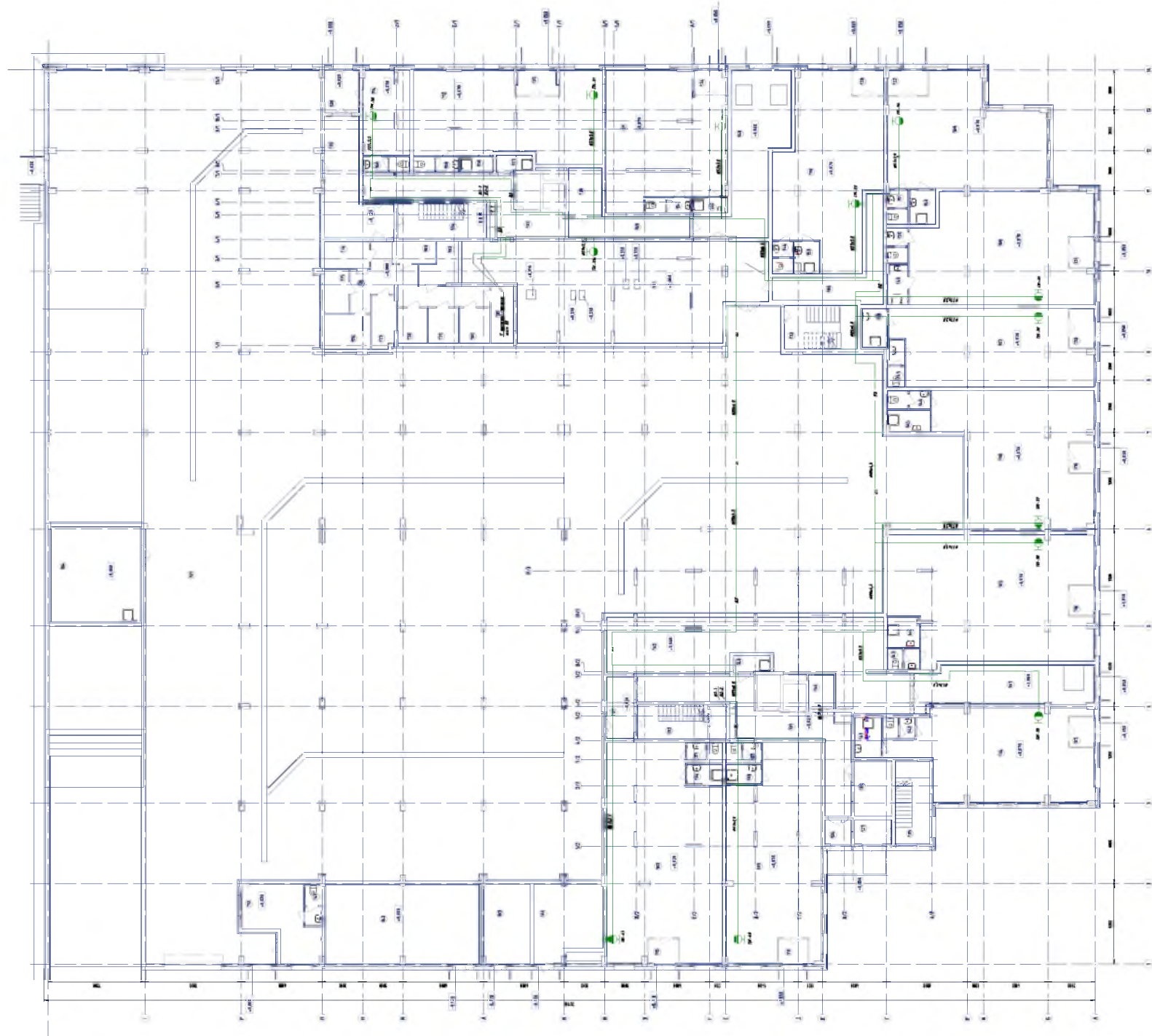

- Таблица обозначения
- 1 - Аккумуляторы
 - 2 - Переключатели
 - 3 - Термостаты
 - 4 - Датчики температуры
 - 5 - Датчики влажности
 - 6 - Датчики давления
 - 7 - Датчики расхода
 - 8 - Датчики уровня
 - 9 - Датчики качества
 - 10 - Датчики воздуха
 - 11 - Датчики света
 - 12 - Датчики звука
 - 13 - Датчики движения
 - 14 - Датчики открытия
 - 15 - Датчики разбития
 - 16 - Датчики порыва
 - 17 - Датчики пожара
 - 18 - Датчики дыма
 - 19 - Датчики газа
 - 20 - Датчики CO₂
 - 21 - Датчики радиации
 - 22 - Датчики магнитного поля

№ п/п	Исполнение	Наименование	Кол-во	Шифр	Сечение	Исполнение	Наименование	Кол-во	Шифр	Сечение
1	11	Аккумуляторы	10	110	0.5	Аккумуляторы	10	110	0.5	0.5
2	11	Переключатели	10	120	0.5	Переключатели	10	120	0.5	0.5
3	11	Термостаты	10	130	0.5	Термостаты	10	130	0.5	0.5
4	11	Датчики температуры	10	140	0.5	Датчики температуры	10	140	0.5	0.5
5	11	Датчики влажности	10	150	0.5	Датчики влажности	10	150	0.5	0.5
6	11	Датчики давления	10	160	0.5	Датчики давления	10	160	0.5	0.5
7	11	Датчики расхода	10	170	0.5	Датчики расхода	10	170	0.5	0.5
8	11	Датчики уровня	10	180	0.5	Датчики уровня	10	180	0.5	0.5
9	11	Датчики качества	10	190	0.5	Датчики качества	10	190	0.5	0.5
10	11	Датчики воздуха	10	200	0.5	Датчики воздуха	10	200	0.5	0.5
11	11	Датчики света	10	210	0.5	Датчики света	10	210	0.5	0.5
12	11	Датчики звука	10	220	0.5	Датчики звука	10	220	0.5	0.5
13	11	Датчики движения	10	230	0.5	Датчики движения	10	230	0.5	0.5
14	11	Датчики открытия	10	240	0.5	Датчики открытия	10	240	0.5	0.5
15	11	Датчики разбития	10	250	0.5	Датчики разбития	10	250	0.5	0.5
16	11	Датчики порыва	10	260	0.5	Датчики порыва	10	260	0.5	0.5
17	11	Датчики пожара	10	270	0.5	Датчики пожара	10	270	0.5	0.5
18	11	Датчики дыма	10	280	0.5	Датчики дыма	10	280	0.5	0.5
19	11	Датчики газа	10	290	0.5	Датчики газа	10	290	0.5	0.5
20	11	Датчики CO ₂	10	300	0.5	Датчики CO ₂	10	300	0.5	0.5
21	11	Датчики радиации	10	310	0.5	Датчики радиации	10	310	0.5	0.5
22	11	Датчики магнитного поля	10	320	0.5	Датчики магнитного поля	10	320	0.5	0.5
23	11	Итого	220			Итого	220			

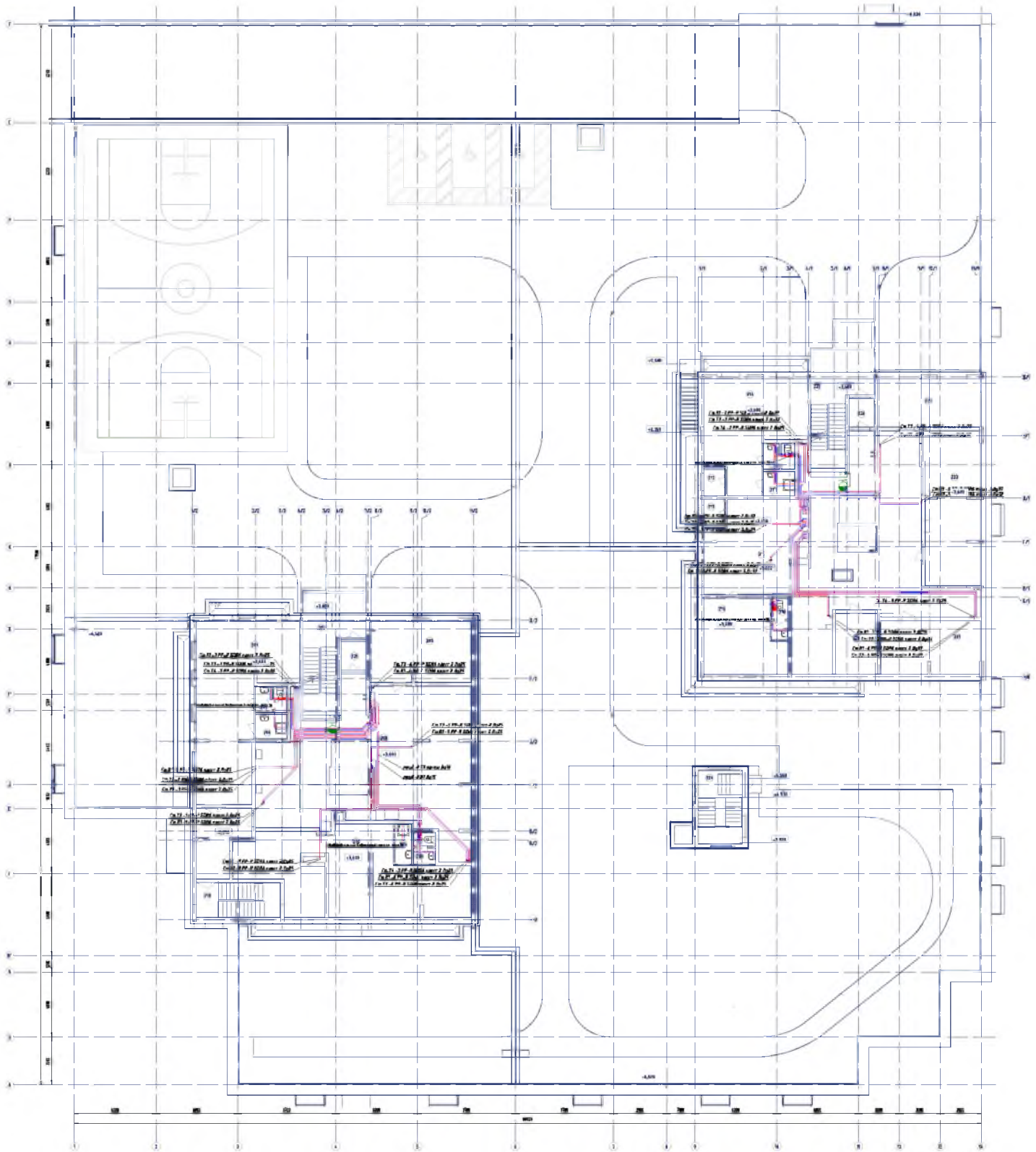

Item No.	Description	Quantity	Unit
01	Concrete structure	100	m ³
02	Reinforcement steel	100	kg
03	Formwork	100	m ²
04	Brickwork	100	m ³
05	Plaster	100	m ²
06	Paint	100	kg
07	Roofing	100	m ²
08	Windows	100	m ²
09	Doors	100	m ²
10	Staircase	100	m ²
11	Sanitary	100	m ²
12	Electrical	100	m ²
13	Plumbing	100	m ²
14	Interior finishing	100	m ²
15	Exterior finishing	100	m ²
16	Landscaping	100	m ²
17	Site works	100	m ²
18	Foundation	100	m ²
19	Structural steel	100	kg
20	Roofing materials	100	m ²
21	Window frames	100	m ²
22	Door frames	100	m ²
23	Staircase components	100	m ²
24	Sanitary fixtures	100	m ²
25	Electrical wiring	100	m ²
26	Plumbing fixtures	100	m ²
27	Interior wall treatments	100	m ²
28	Exterior wall treatments	100	m ²
29	Site preparation	100	m ²
30	Foundation works	100	m ²
31	Structural steel erection	100	m ²
32	Roofing installation	100	m ²
33	Window installation	100	m ²
34	Door installation	100	m ²
35	Staircase construction	100	m ²
36	Sanitary installation	100	m ²
37	Electrical installation	100	m ²
38	Plumbing installation	100	m ²
39	Interior finishing works	100	m ²
40	Exterior finishing works	100	m ²
41	Landscaping works	100	m ²
42	Site works	100	m ²
43	Foundation works	100	m ²
44	Structural steel works	100	m ²
45	Roofing works	100	m ²
46	Window works	100	m ²
47	Door works	100	m ²
48	Staircase works	100	m ²
49	Sanitary works	100	m ²
50	Electrical works	100	m ²
51	Plumbing works	100	m ²
52	Interior finishing works	100	m ²
53	Exterior finishing works	100	m ²
54	Landscaping works	100	m ²
55	Site works	100	m ²
56	Foundation works	100	m ²
57	Structural steel works	100	m ²
58	Roofing works	100	m ²
59	Window works	100	m ²
60	Door works	100	m ²
61	Staircase works	100	m ²
62	Sanitary works	100	m ²
63	Electrical works	100	m ²
64	Plumbing works	100	m ²
65	Interior finishing works	100	m ²
66	Exterior finishing works	100	m ²
67	Landscaping works	100	m ²
68	Site works	100	m ²
69	Foundation works	100	m ²
70	Structural steel works	100	m ²
71	Roofing works	100	m ²
72	Window works	100	m ²
73	Door works	100	m ²
74	Staircase works	100	m ²
75	Sanitary works	100	m ²
76	Electrical works	100	m ²
77	Plumbing works	100	m ²
78	Interior finishing works	100	m ²
79	Exterior finishing works	100	m ²
80	Landscaping works	100	m ²
81	Site works	100	m ²
82	Foundation works	100	m ²
83	Structural steel works	100	m ²
84	Roofing works	100	m ²
85	Window works	100	m ²
86	Door works	100	m ²
87	Staircase works	100	m ²
88	Sanitary works	100	m ²
89	Electrical works	100	m ²
90	Plumbing works	100	m ²
91	Interior finishing works	100	m ²
92	Exterior finishing works	100	m ²
93	Landscaping works	100	m ²
94	Site works	100	m ²
95	Foundation works	100	m ²
96	Structural steel works	100	m ²
97	Roofing works	100	m ²
98	Window works	100	m ²
99	Door works	100	m ²
100	Staircase works	100	m ²

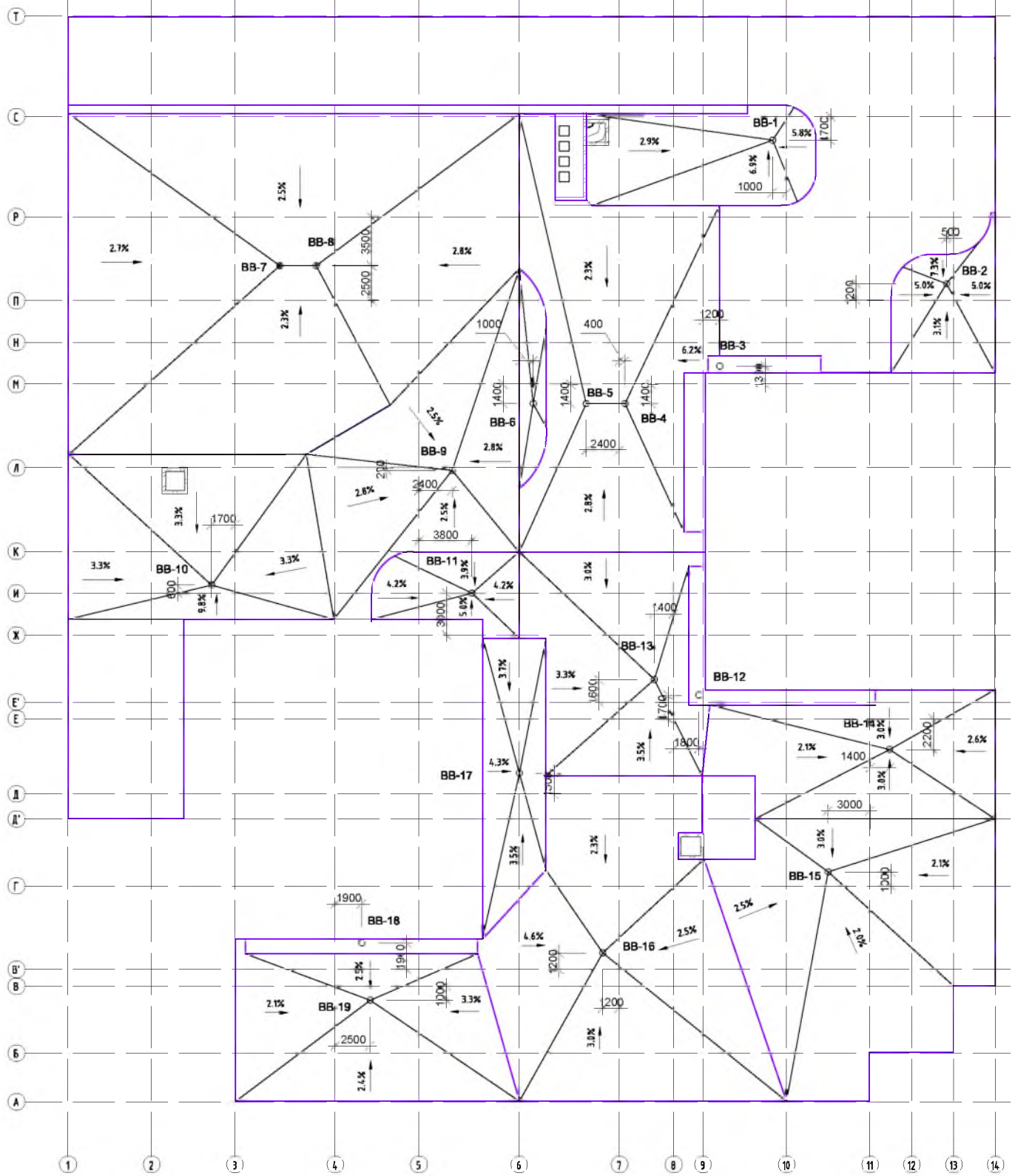

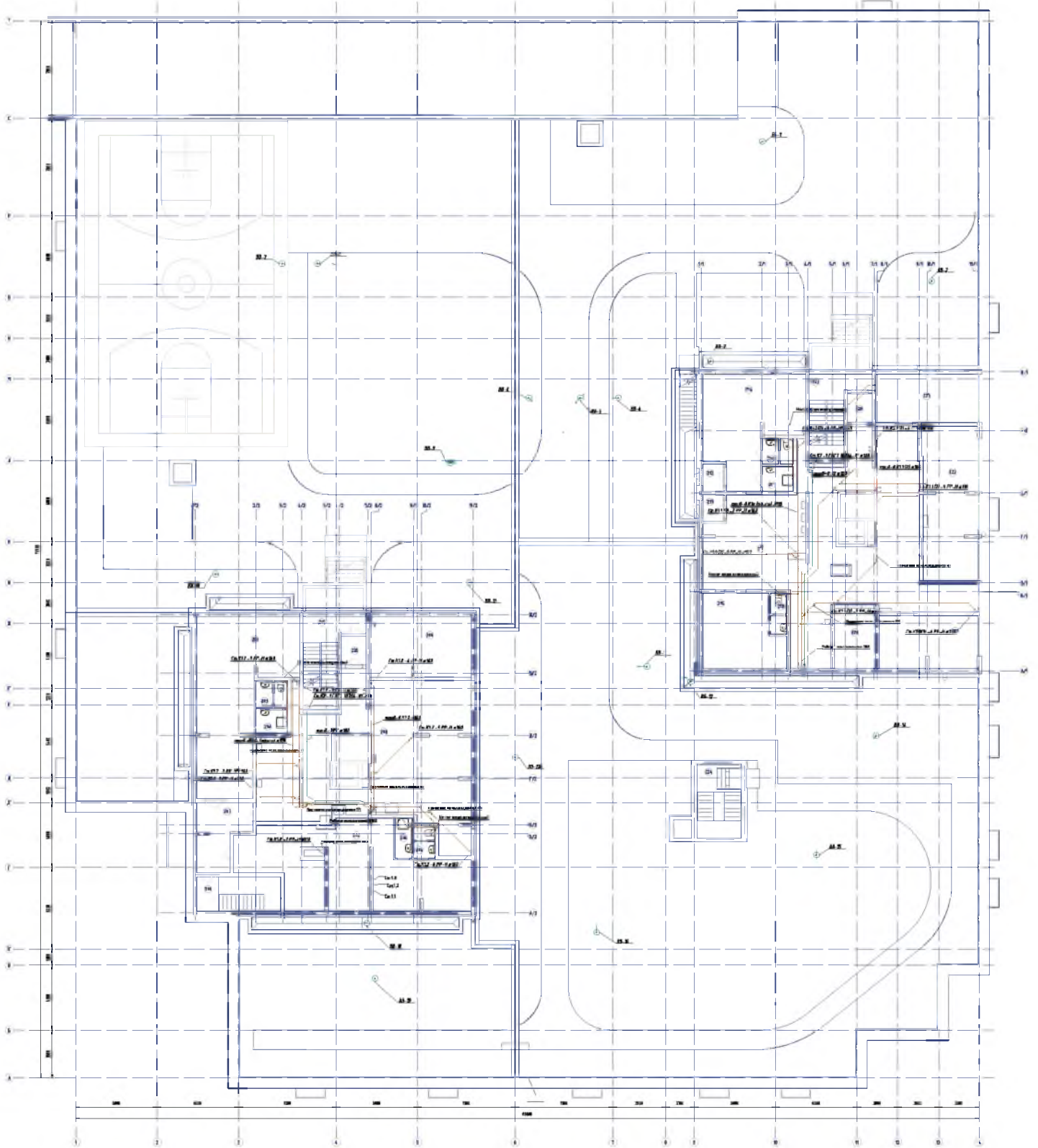

Item no.	Description	Quantity	Unit
20	Concrete floor screed	11.0	m ²
21	Concrete floor screed	11.0	m ²
22	Concrete floor screed	11.0	m ²
23	Concrete floor screed	11.0	m ²
24	Concrete floor screed	11.0	m ²
25	Concrete floor screed	11.0	m ²
26	Concrete floor screed	11.0	m ²
27	Concrete floor screed	11.0	m ²
28	Concrete floor screed	11.0	m ²
29	Concrete floor screed	11.0	m ²
30	Concrete floor screed	11.0	m ²
31	Concrete floor screed	11.0	m ²
32	Concrete floor screed	11.0	m ²
33	Concrete floor screed	11.0	m ²
34	Concrete floor screed	11.0	m ²
35	Concrete floor screed	11.0	m ²
36	Concrete floor screed	11.0	m ²
37	Concrete floor screed	11.0	m ²
38	Concrete floor screed	11.0	m ²
39	Concrete floor screed	11.0	m ²
40	Concrete floor screed	11.0	m ²
41	Concrete floor screed	11.0	m ²
42	Concrete floor screed	11.0	m ²
43	Concrete floor screed	11.0	m ²
44	Concrete floor screed	11.0	m ²
45	Concrete floor screed	11.0	m ²
46	Concrete floor screed	11.0	m ²
47	Concrete floor screed	11.0	m ²
48	Concrete floor screed	11.0	m ²
49	Concrete floor screed	11.0	m ²
50	Concrete floor screed	11.0	m ²
51	Concrete floor screed	11.0	m ²
52	Concrete floor screed	11.0	m ²
53	Concrete floor screed	11.0	m ²
54	Concrete floor screed	11.0	m ²
55	Concrete floor screed	11.0	m ²
56	Concrete floor screed	11.0	m ²
57	Concrete floor screed	11.0	m ²
58	Concrete floor screed	11.0	m ²
59	Concrete floor screed	11.0	m ²
60	Concrete floor screed	11.0	m ²
61	Concrete floor screed	11.0	m ²
62	Concrete floor screed	11.0	m ²
63	Concrete floor screed	11.0	m ²
64	Concrete floor screed	11.0	m ²
65	Concrete floor screed	11.0	m ²
66	Concrete floor screed	11.0	m ²
67	Concrete floor screed	11.0	m ²
68	Concrete floor screed	11.0	m ²
69	Concrete floor screed	11.0	m ²
70	Concrete floor screed	11.0	m ²
71	Concrete floor screed	11.0	m ²
72	Concrete floor screed	11.0	m ²
73	Concrete floor screed	11.0	m ²
74	Concrete floor screed	11.0	m ²
75	Concrete floor screed	11.0	m ²
76	Concrete floor screed	11.0	m ²
77	Concrete floor screed	11.0	m ²
78	Concrete floor screed	11.0	m ²
79	Concrete floor screed	11.0	m ²
80	Concrete floor screed	11.0	m ²
81	Concrete floor screed	11.0	m ²
82	Concrete floor screed	11.0	m ²
83	Concrete floor screed	11.0	m ²
84	Concrete floor screed	11.0	m ²
85	Concrete floor screed	11.0	m ²
86	Concrete floor screed	11.0	m ²
87	Concrete floor screed	11.0	m ²
88	Concrete floor screed	11.0	m ²
89	Concrete floor screed	11.0	m ²
90	Concrete floor screed	11.0	m ²
91	Concrete floor screed	11.0	m ²
92	Concrete floor screed	11.0	m ²
93	Concrete floor screed	11.0	m ²
94	Concrete floor screed	11.0	m ²
95	Concrete floor screed	11.0	m ²
96	Concrete floor screed	11.0	m ²
97	Concrete floor screed	11.0	m ²
98	Concrete floor screed	11.0	m ²
99	Concrete floor screed	11.0	m ²
100	Concrete floor screed	11.0	m ²

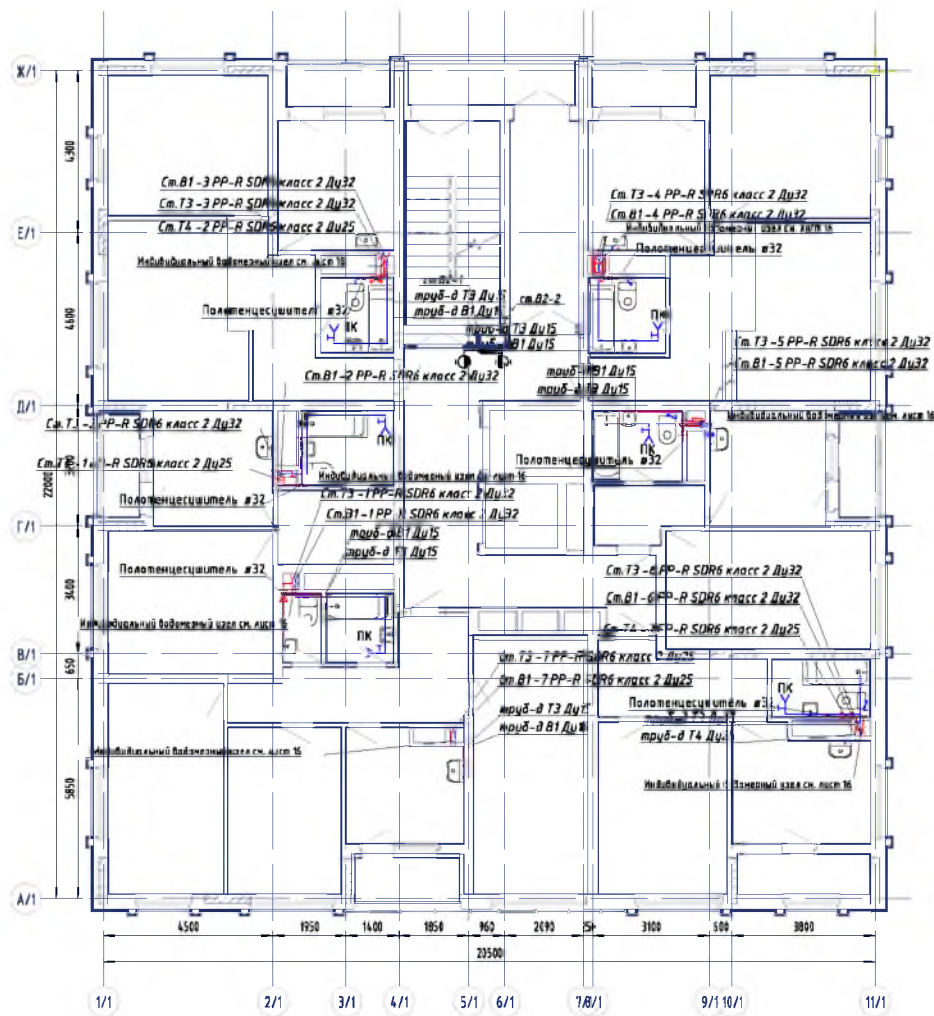

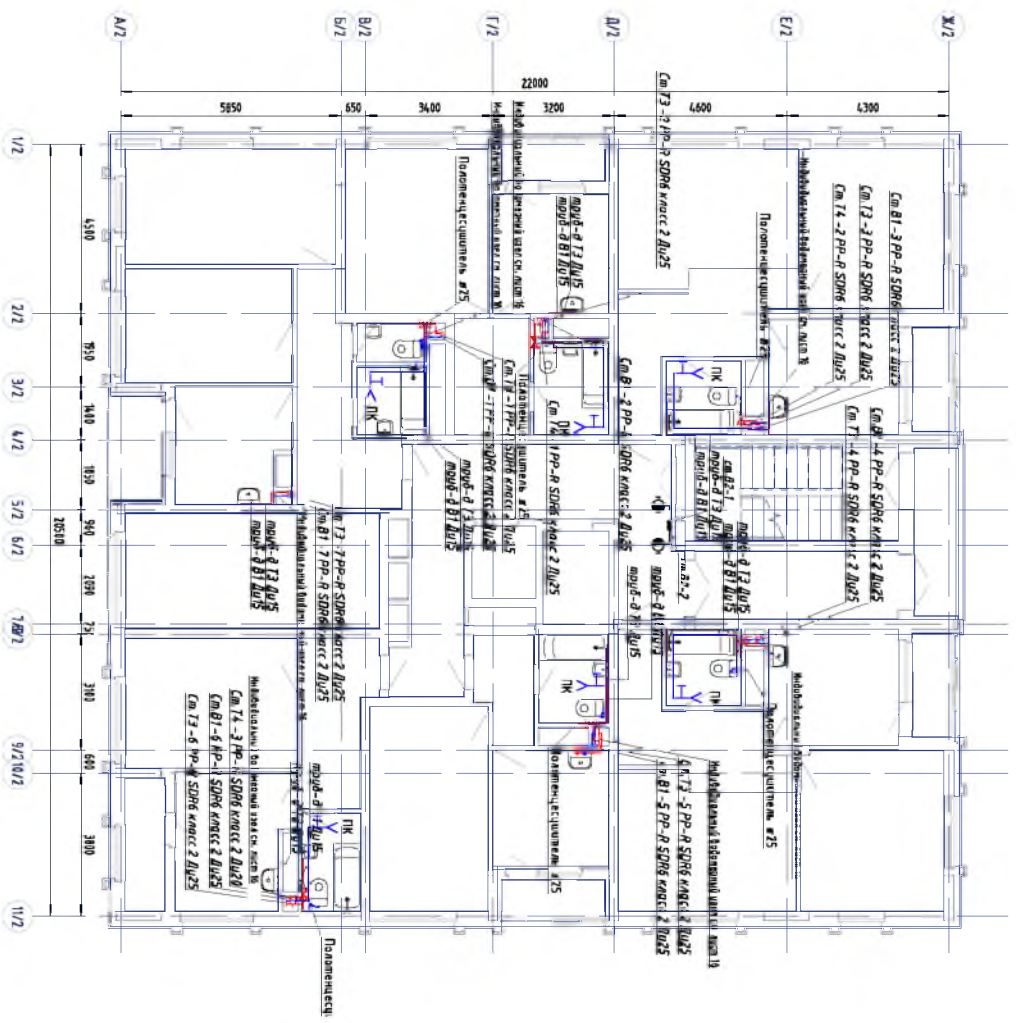

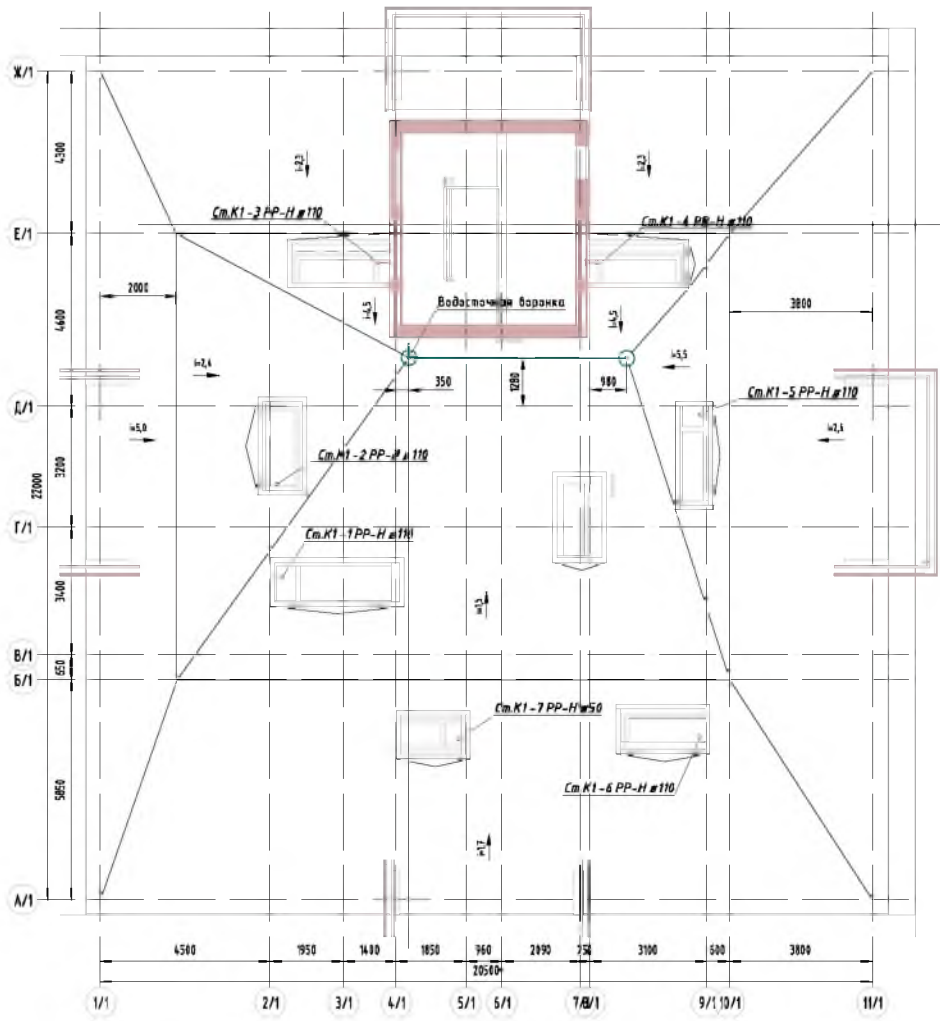

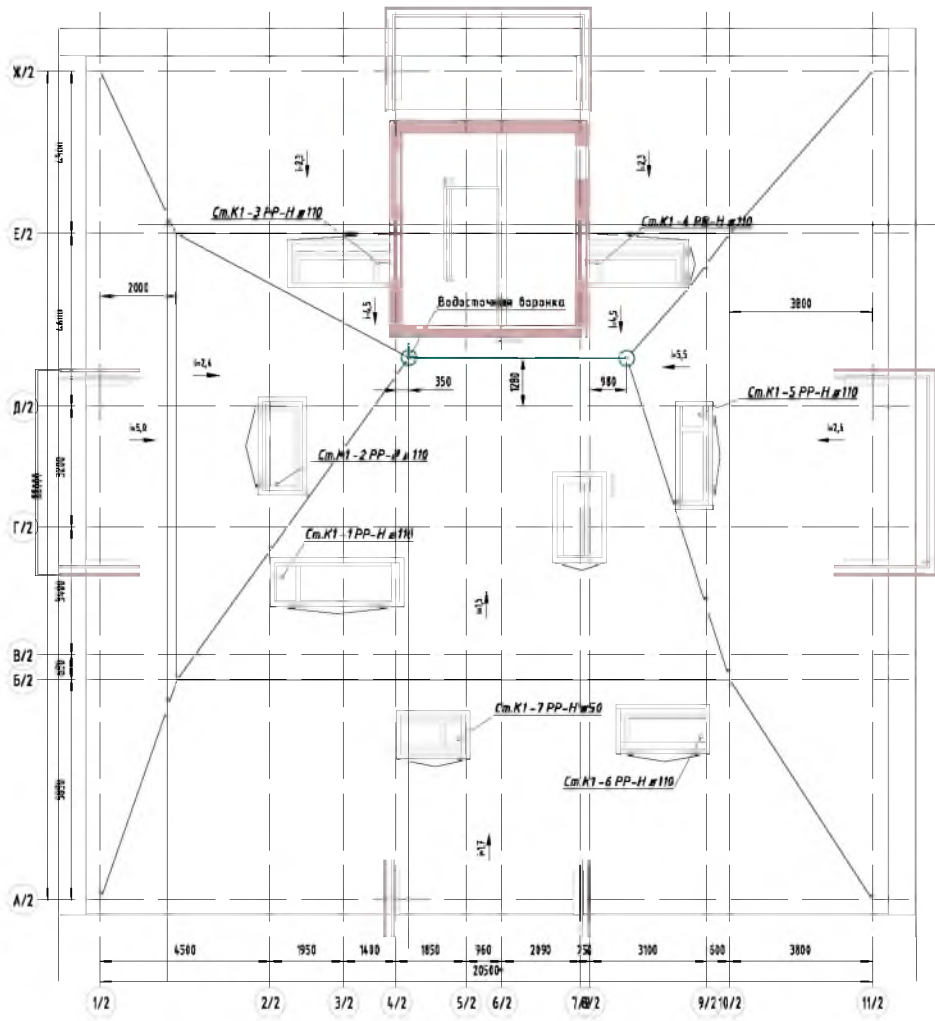

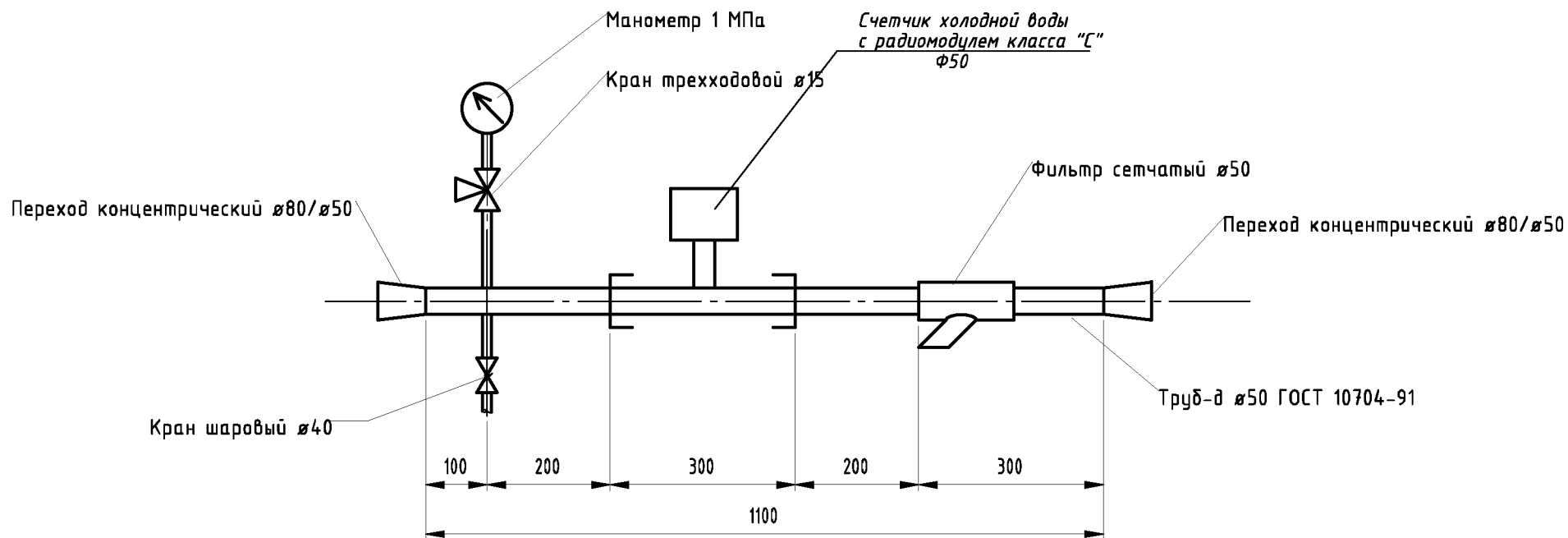

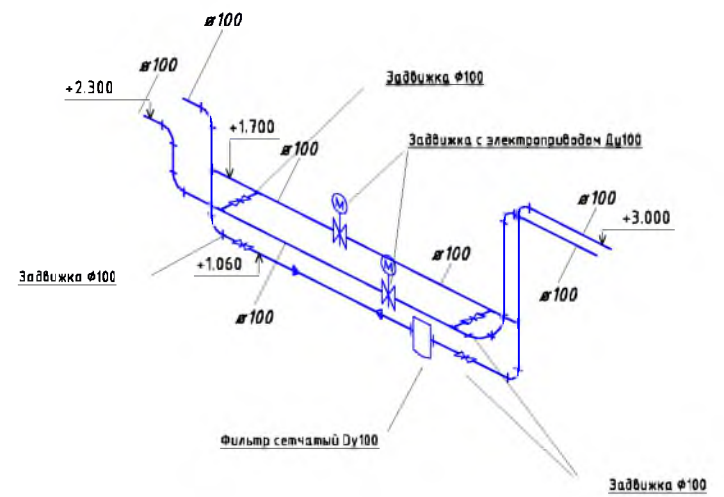
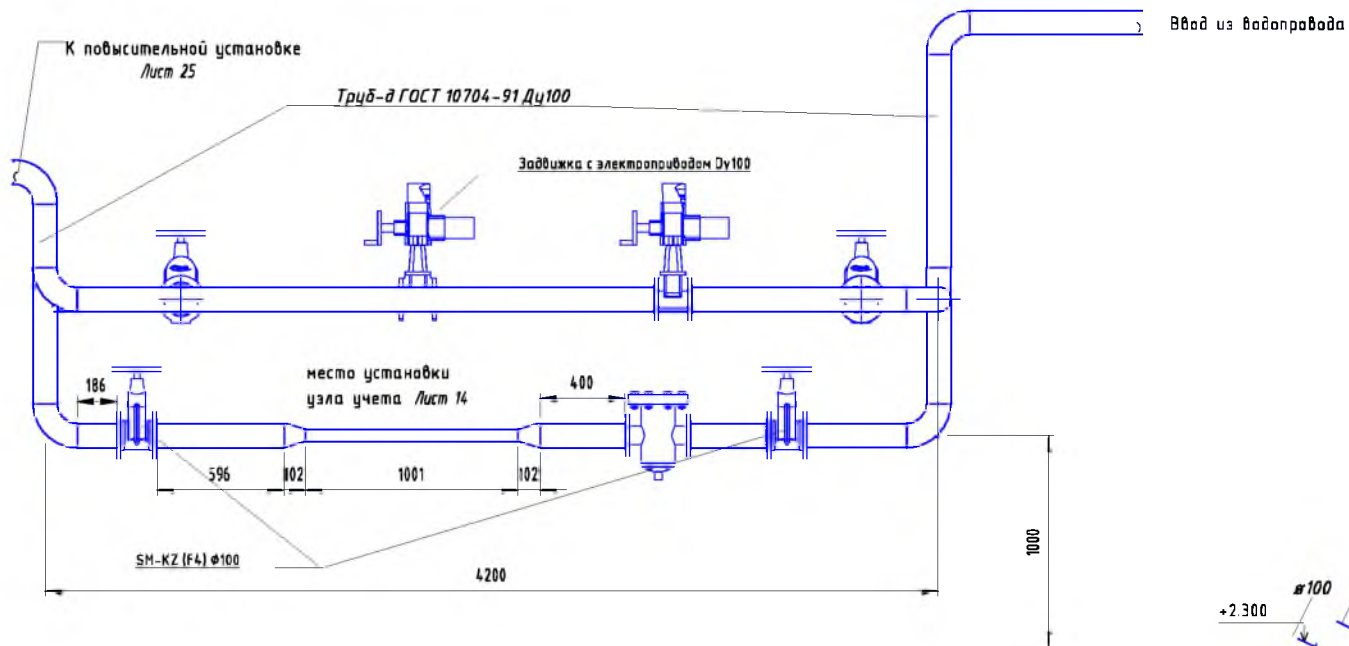

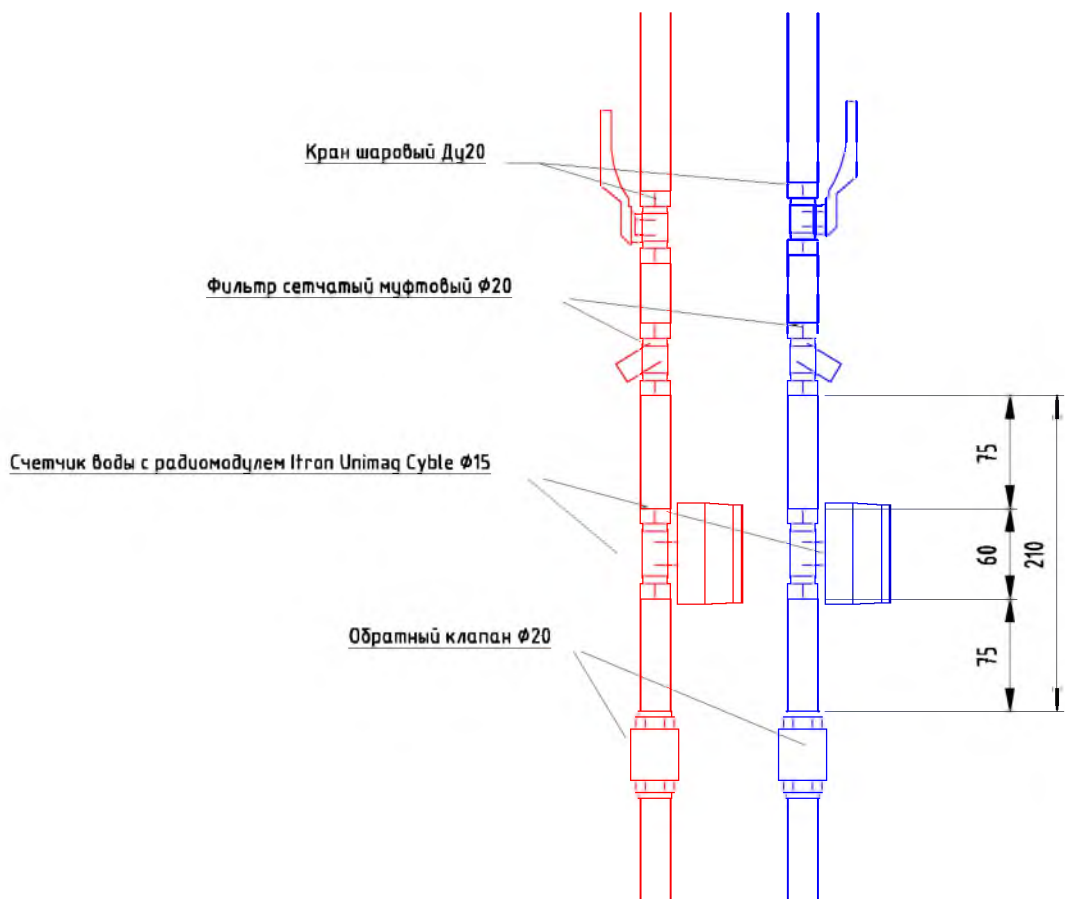

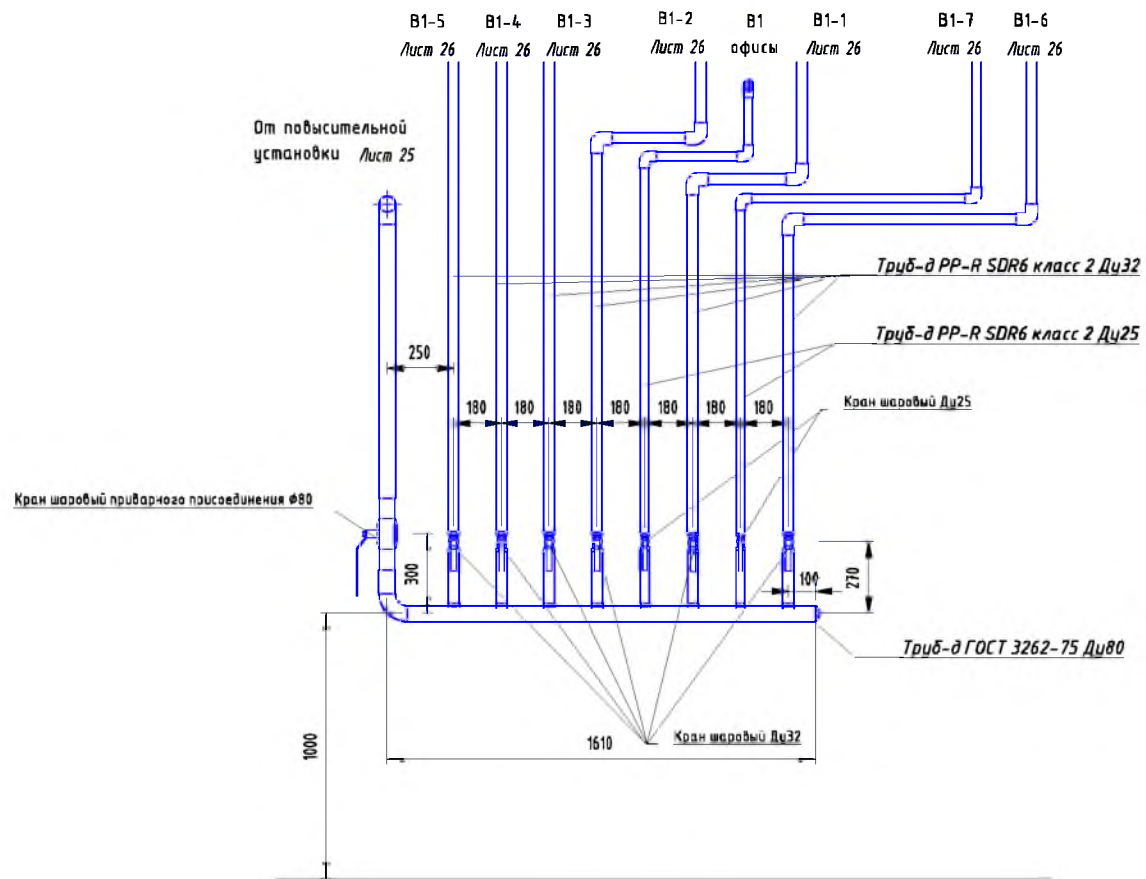

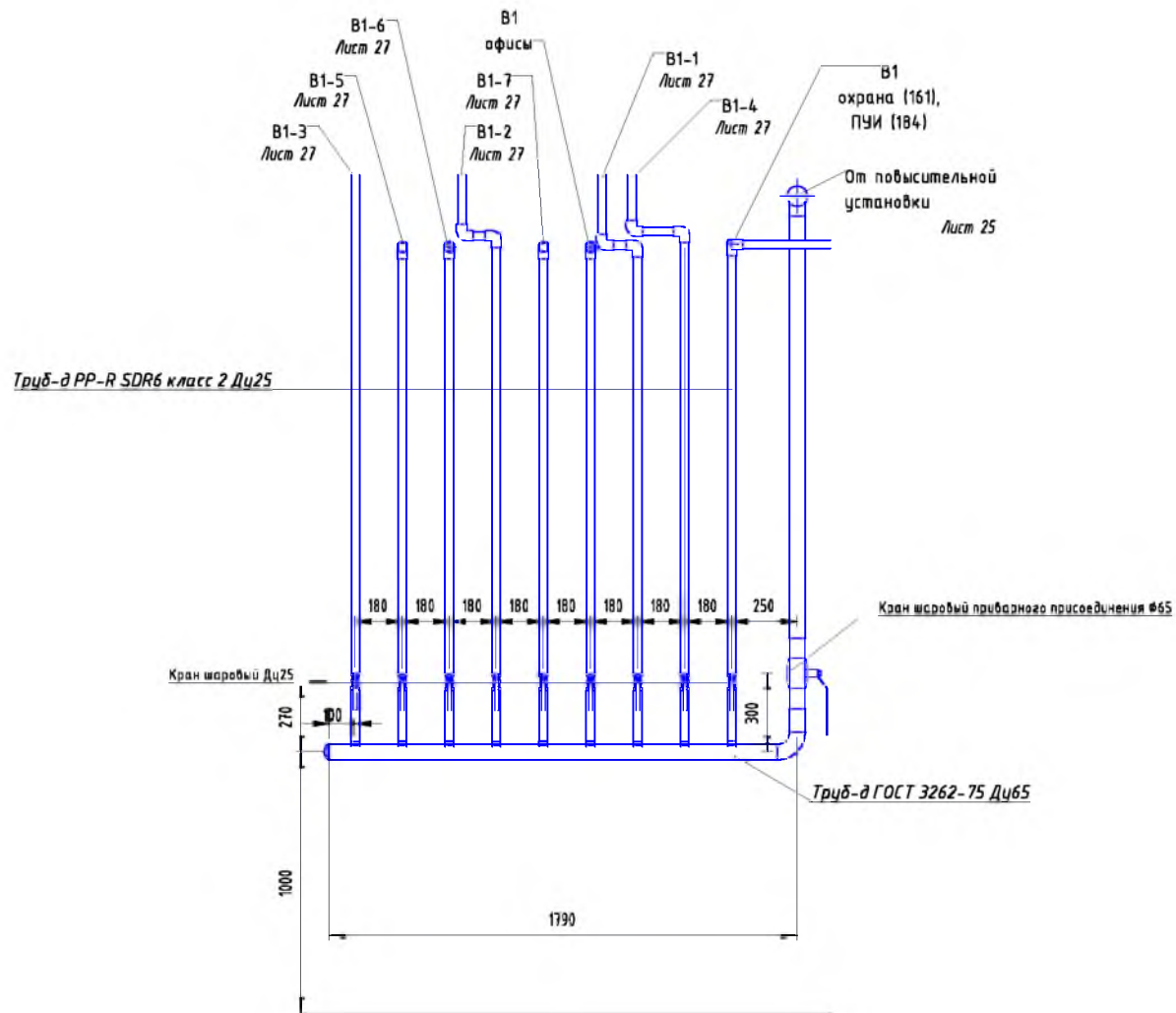

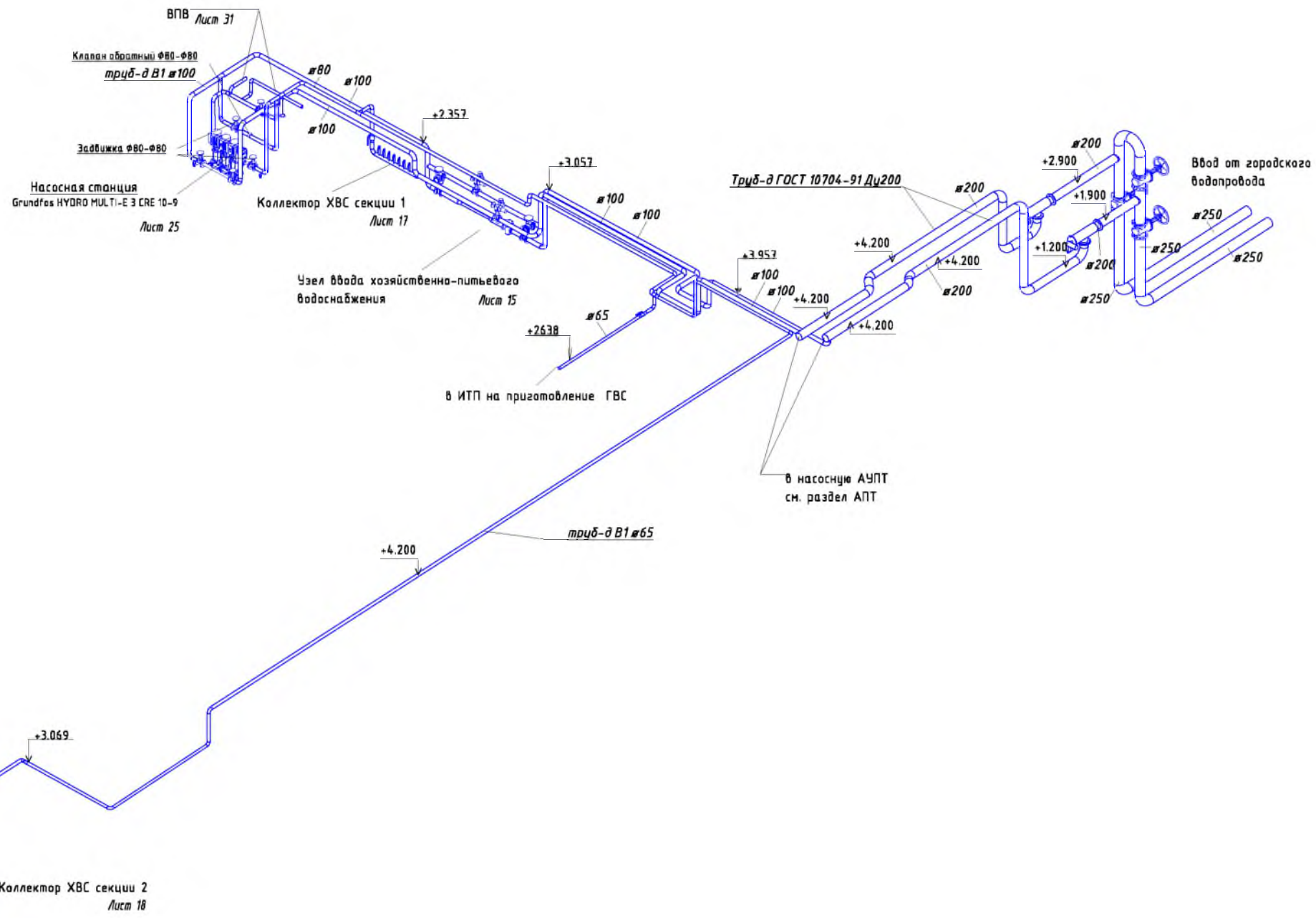

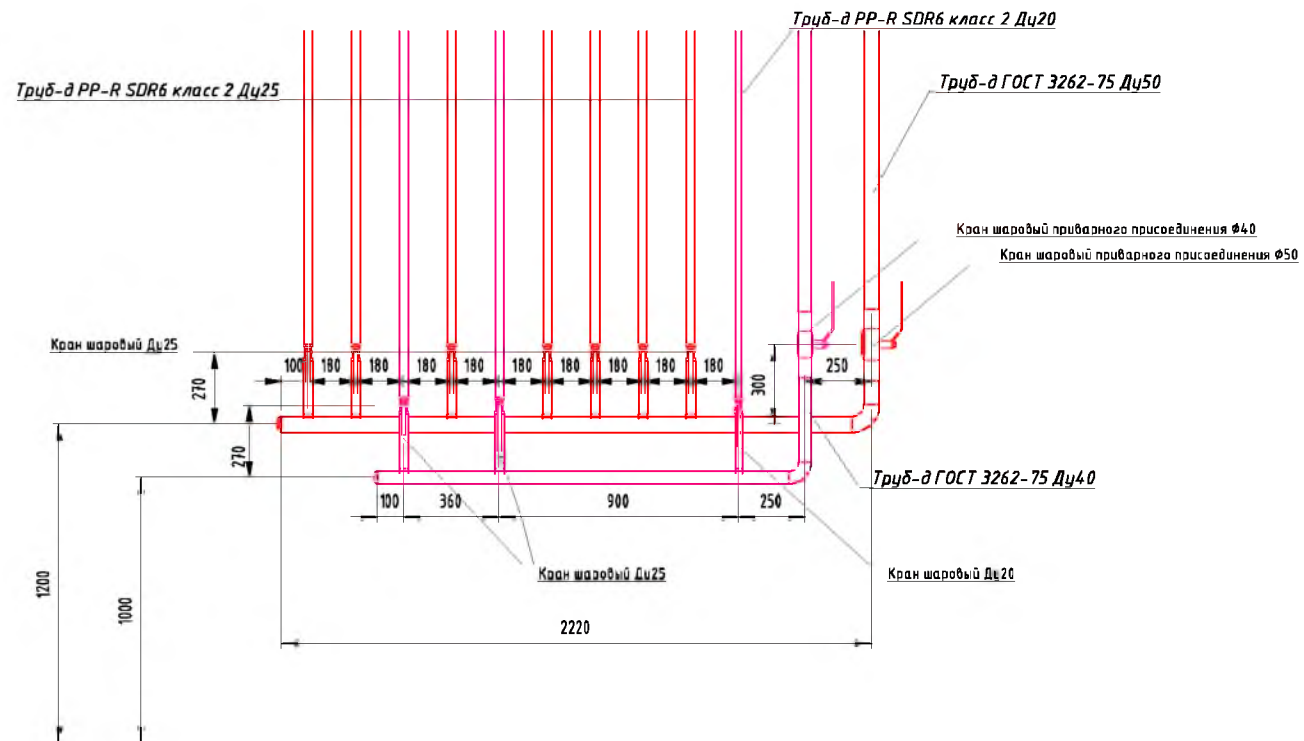

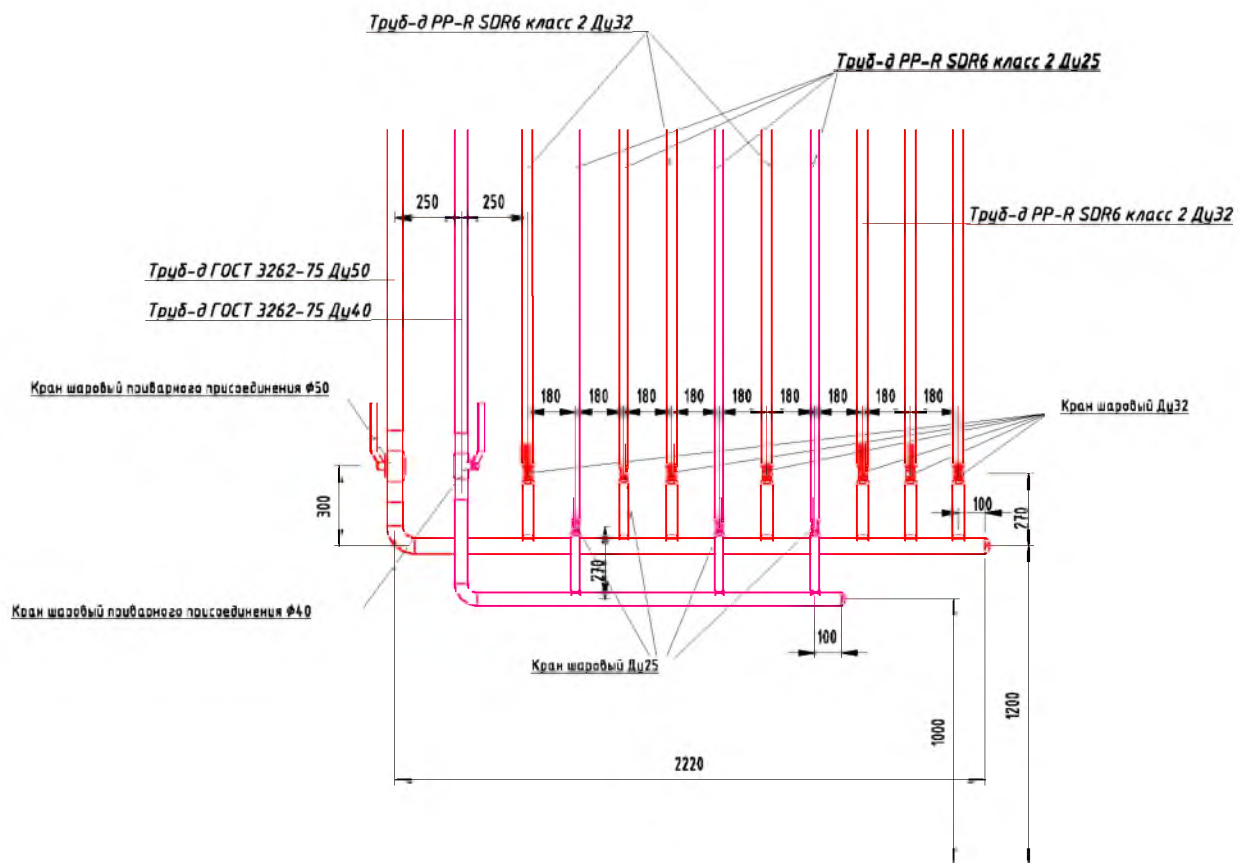

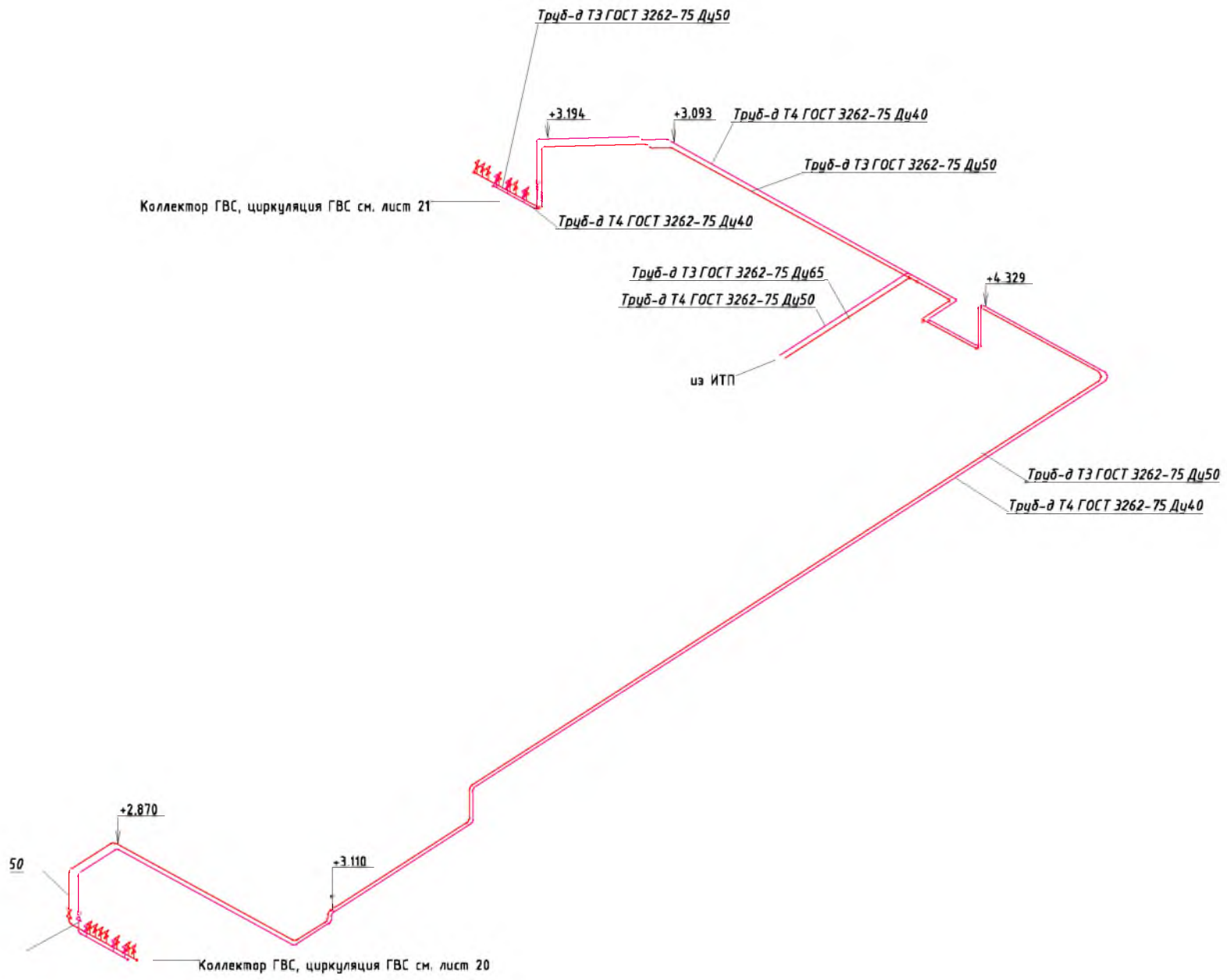

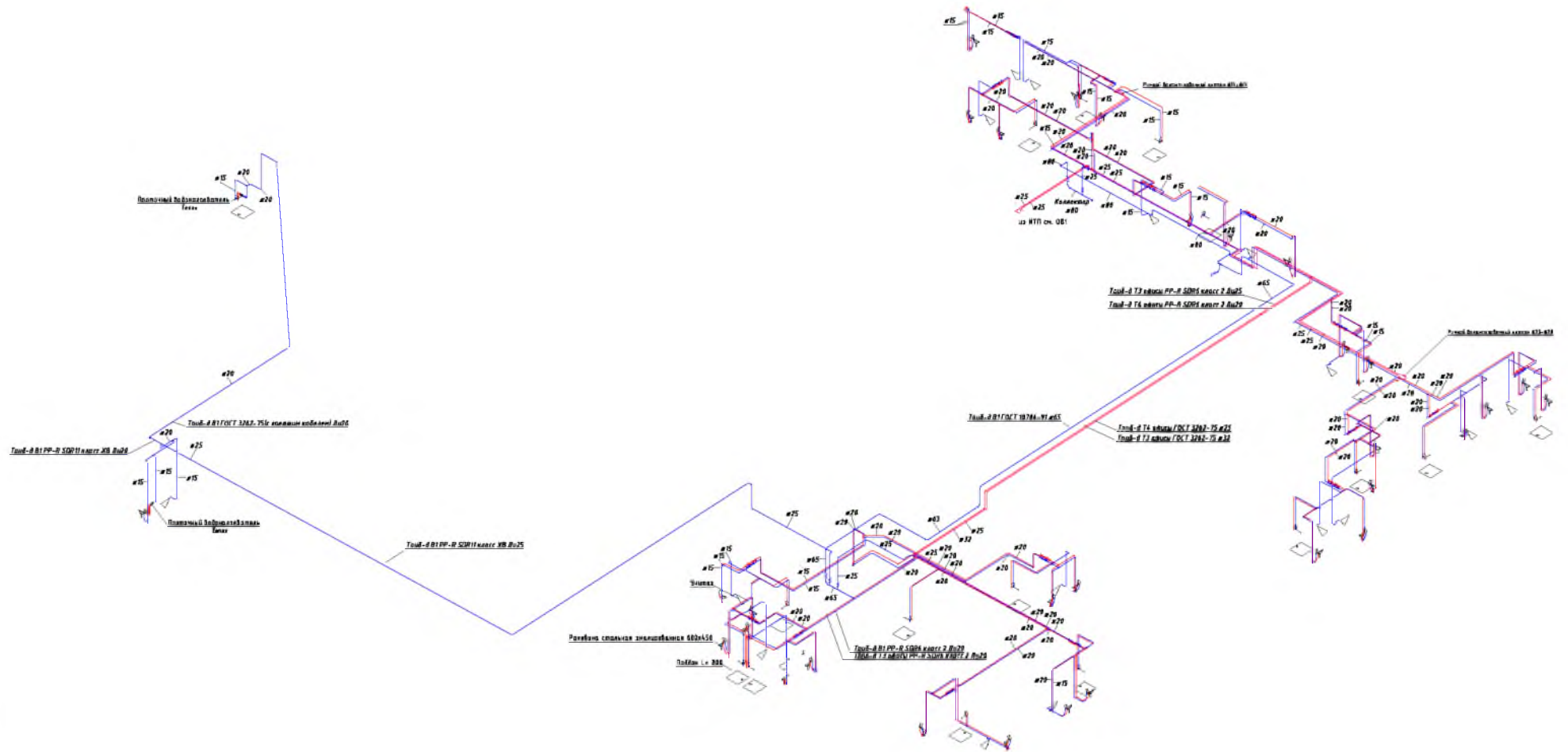

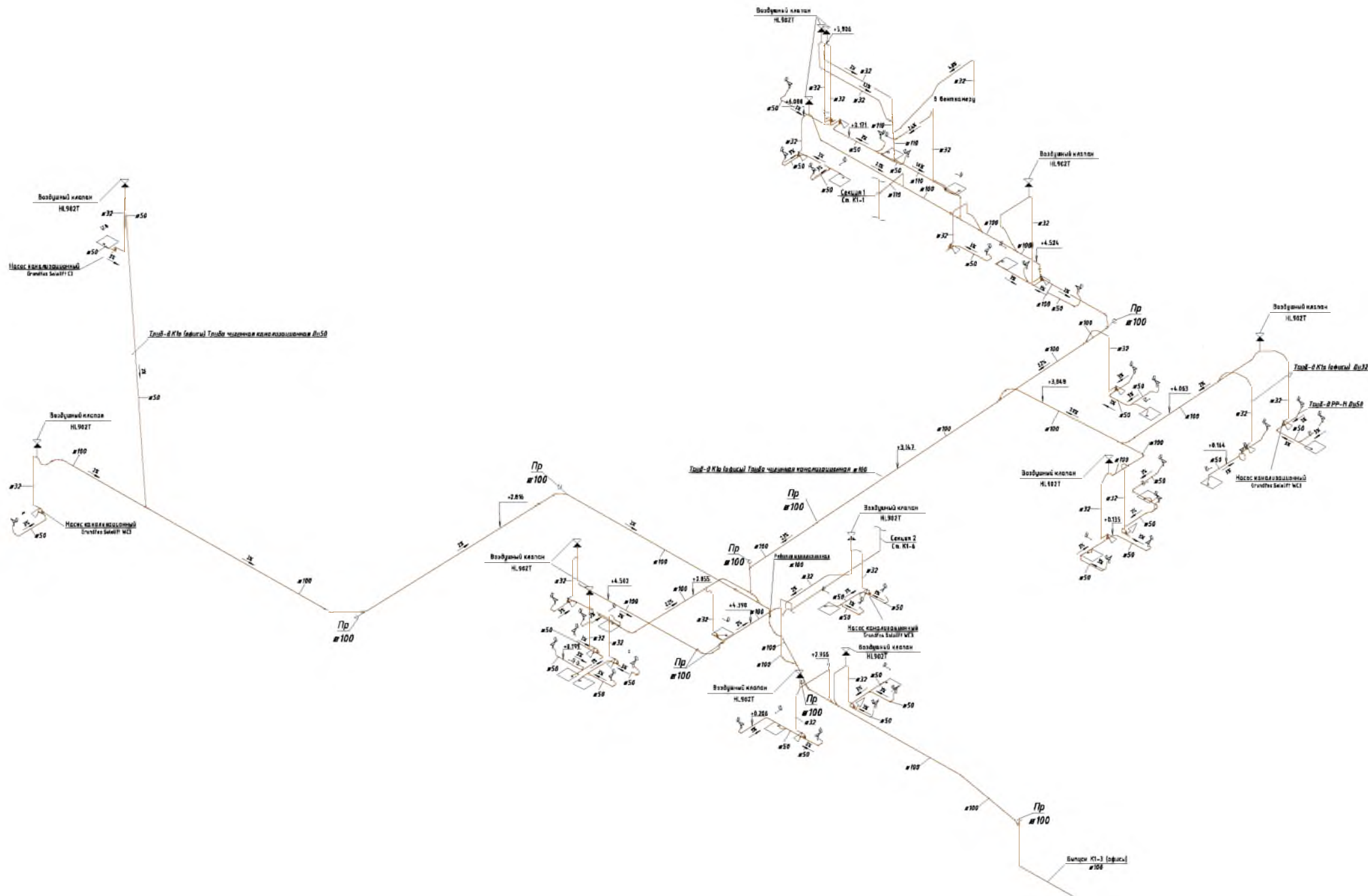

Секция 2

Секция 1

Схемы стояков ст.
Лист 29

Схемы стояков ст.
Лист 28

