

ПЕРШИЙ ПОВЕРХ

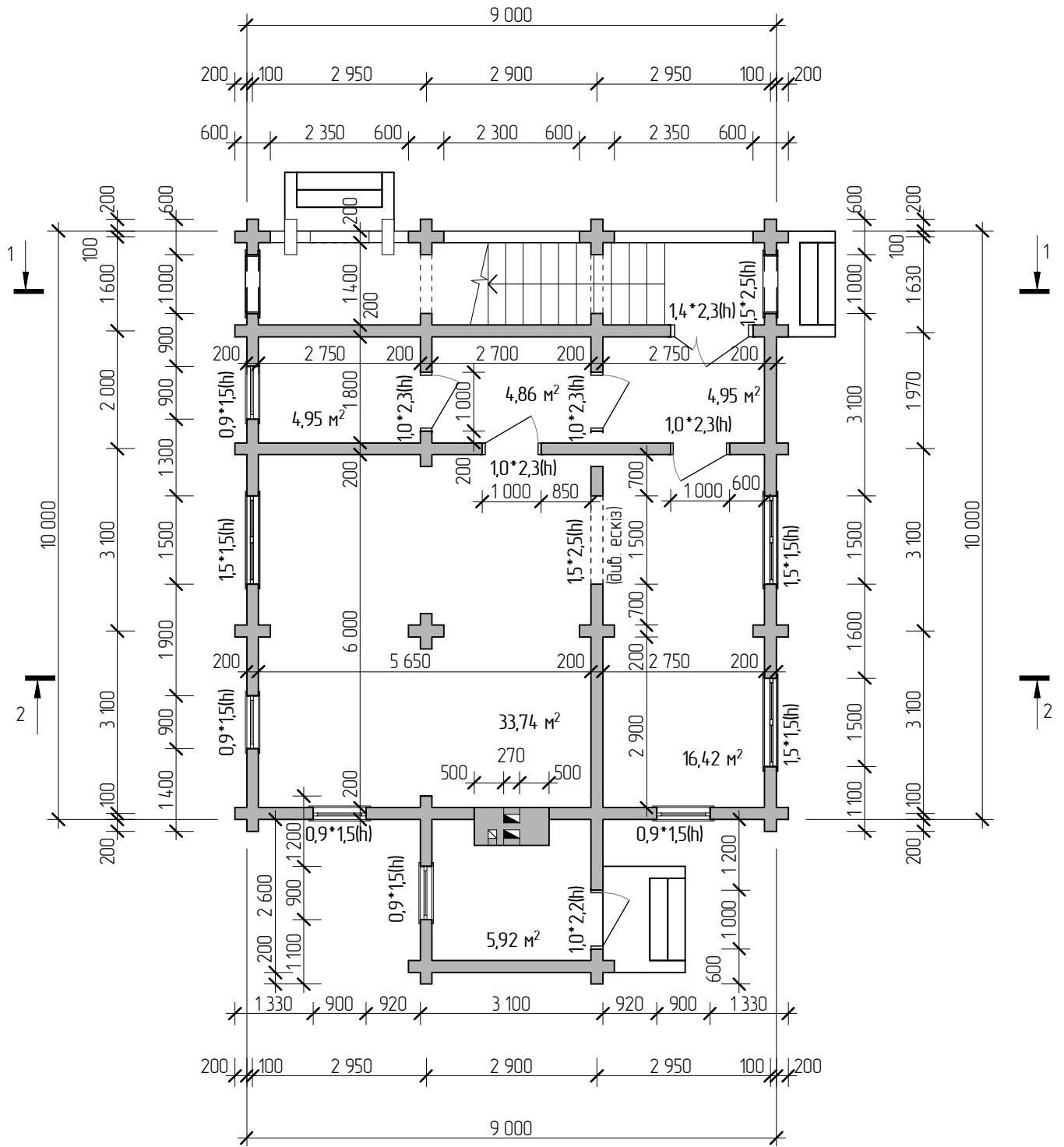

ЕСКИЗ

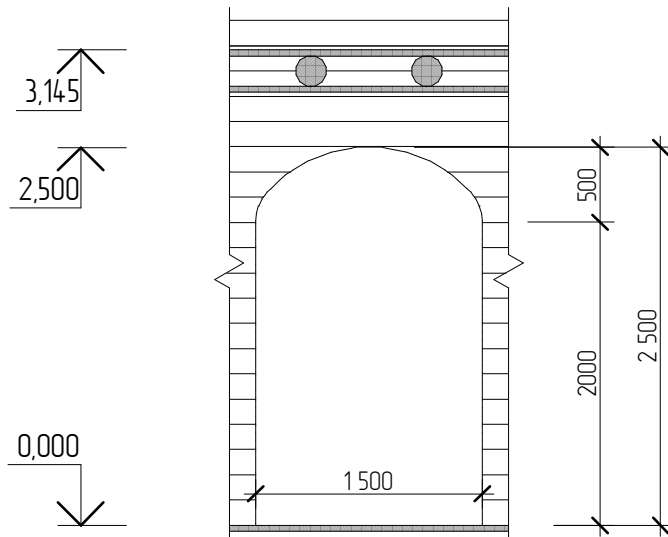

P03PI3 1-1

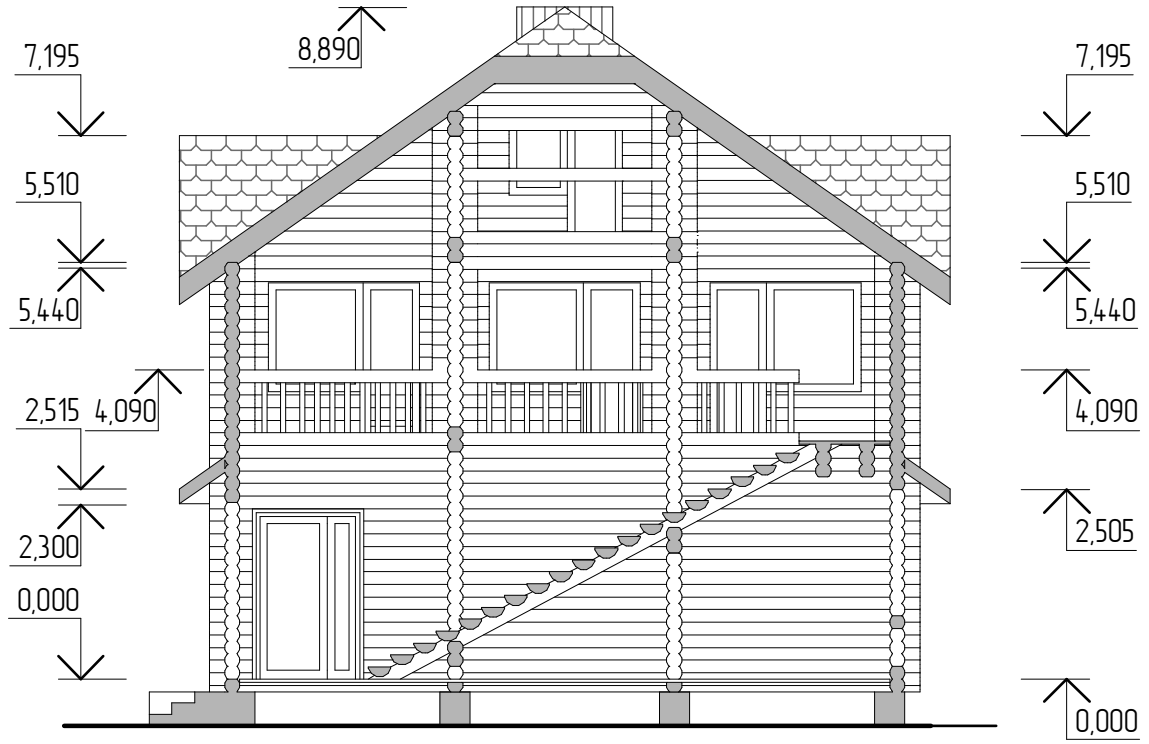

P03PI3 2-2

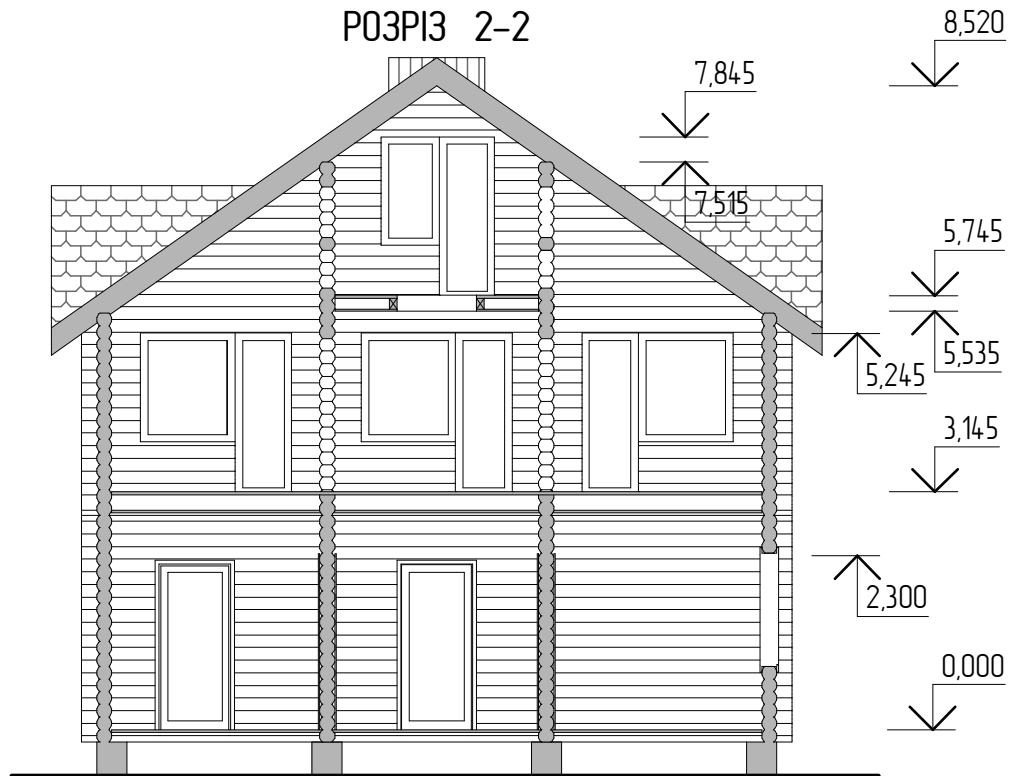

МАНСАРДНИЙ ПОВЕРХ



СХЕМА ПЕРЕКРИТТЯ ПЕРШОГО ПОВЕРХУ



ПЛАН ФУНДАМЕНТІВ

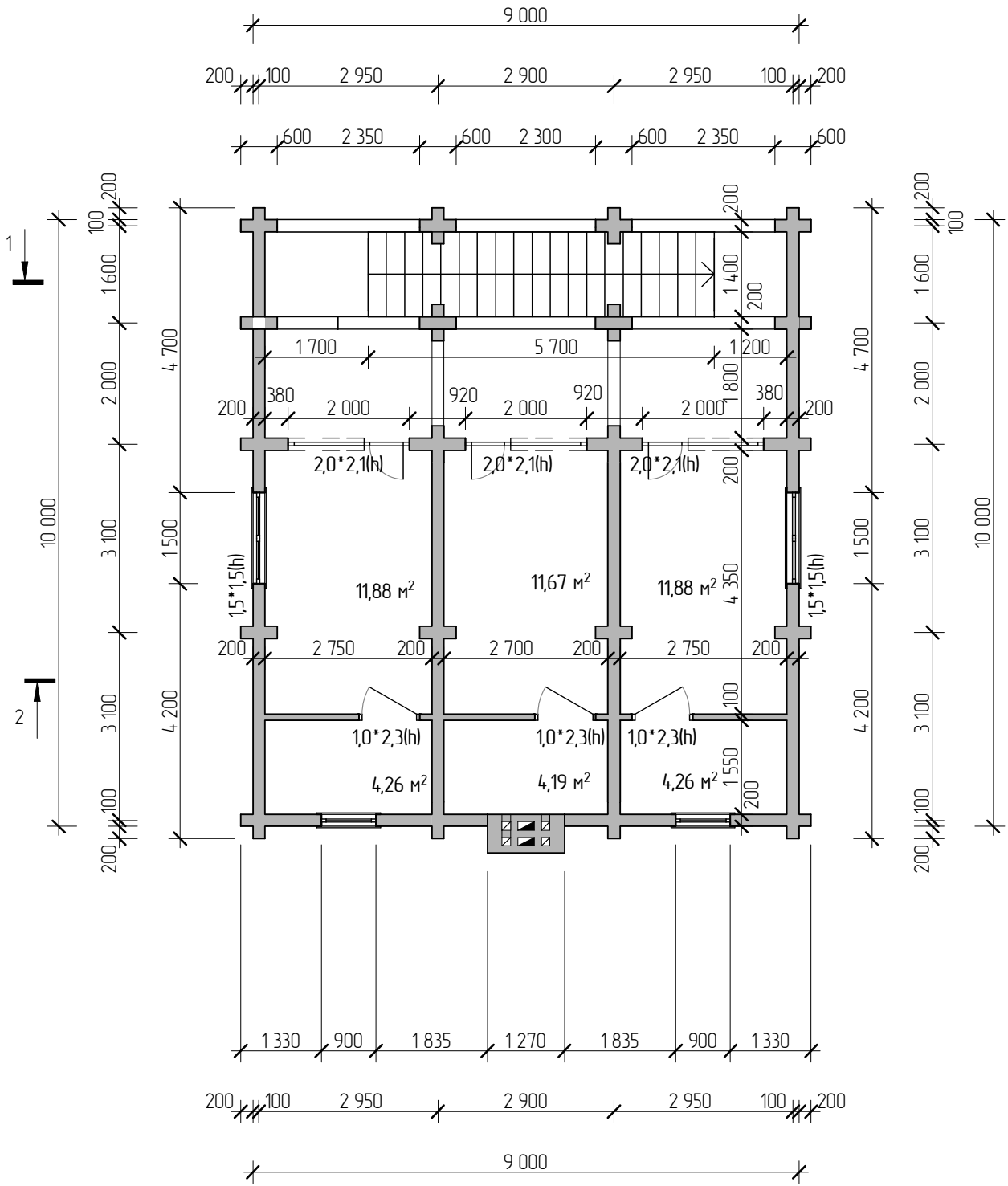
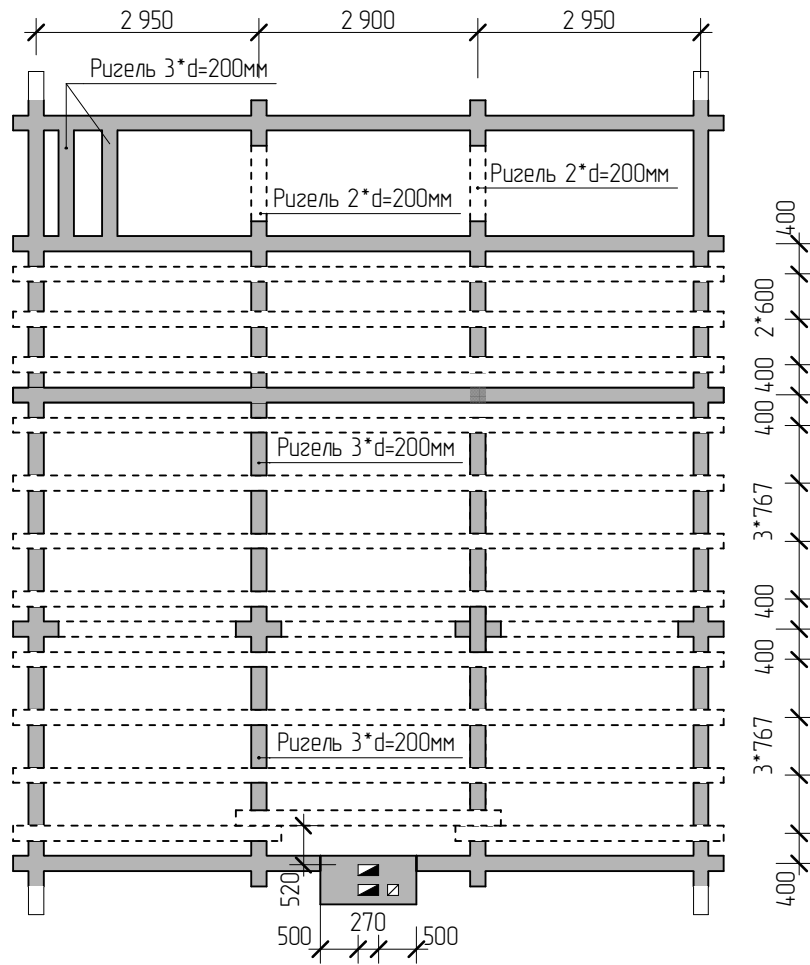
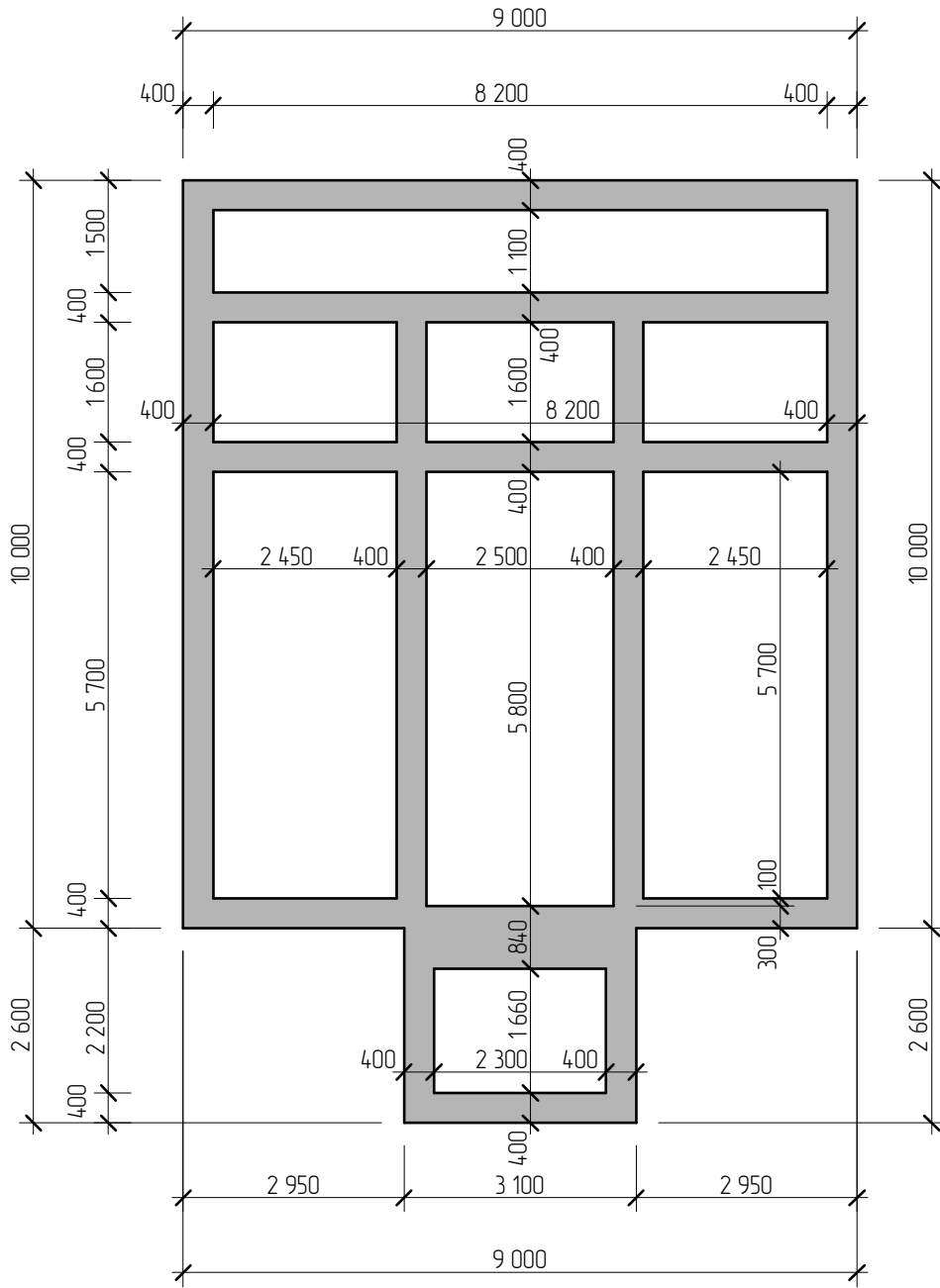

ПЛАН ДАХУ



СХЕМА РОЗМІЩЕННЯ ЕЛЕМЕНТІВ КРОВ'ЯНОЇ С-МИ



КРОВ'ЯНА С-МА. ЗАГАЛЬНИЙ ВИГЛЯД

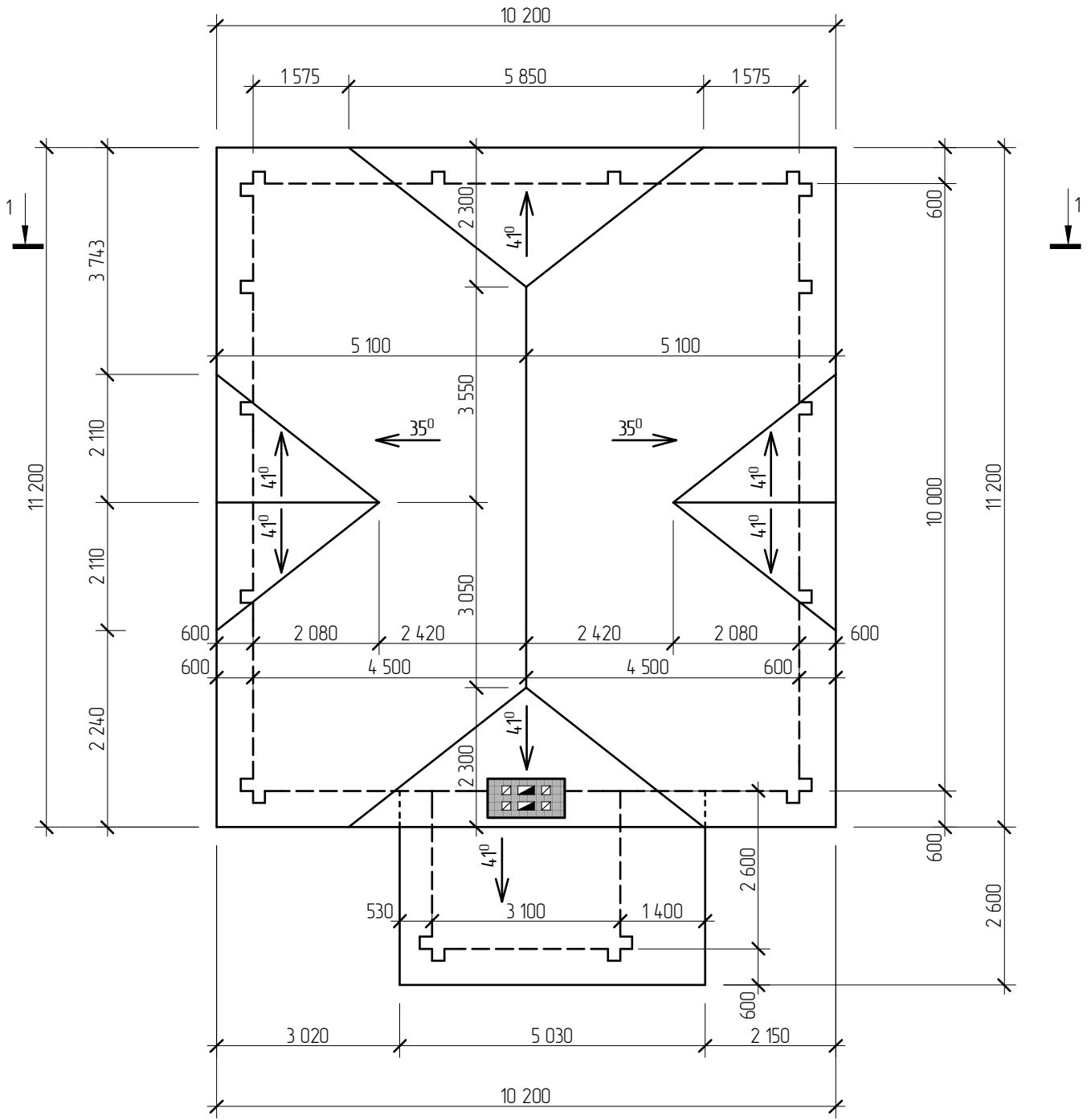
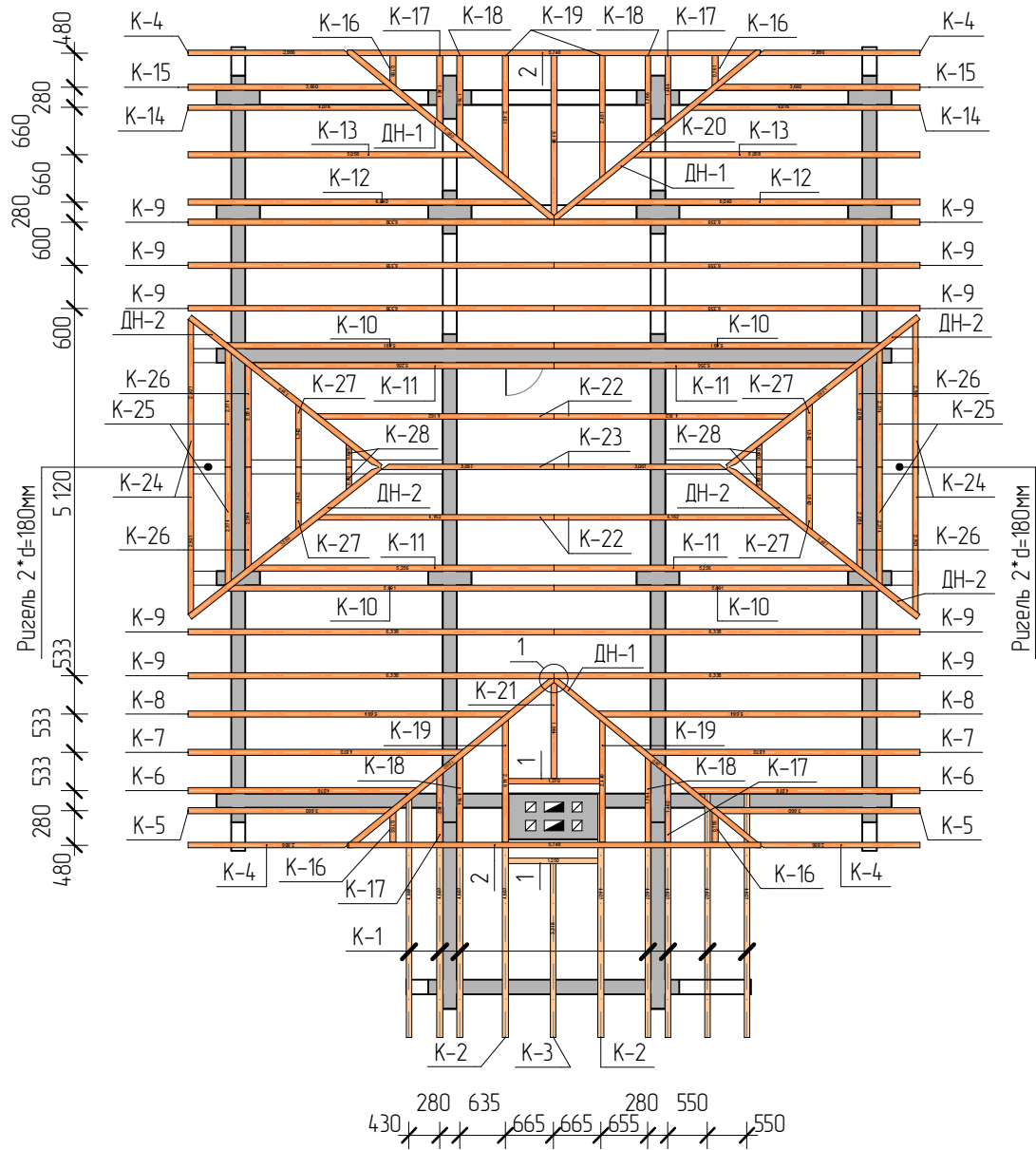